

© Copyright 2013, TL elektronik
Non TSO approved

INTEGRA EFIS TL-6560 USER MANUAL



TL ELEKTRONIC INC.

TL elektronik
Airport, Building 125
503 41 Hradec Kralove
Czech Republic

© Copyright 2013
TL elektronik
All Rights Reserved

Except as expressly provided below, no part of this manual may be downloaded, transmitted, copied, reproduced, disseminated or stored in any storage medium, for any purpose without the express prior written consent of the TL elektronik company. Address your questions about the technical information to TL elektronik. Other information about sale, distribution should be directed to our exclusive distributors (see World Distributor list on our website).

Producer's address:
TL elektronik Inc.
Airport, Building 125,
503 41 Hradec Kralove, Czech Republic
Fax: +420 49 548 23 94 E-mail: info@tl-elektronic.com
Web Site Address: www.tl-elektronic.com

Please, send your e-mail address to customer@tl-elektronic.com to receive the latest information about software upgrade.

Send your ideas to innovation@tl-elektronic.com
We will evaluate your suggestion and provide an update.

Windows is registered trademark of Microsoft Corporation.
All trademarks and registered trademarks are acknowledged.
ScheckK® is registered trademark of TL elektronik.
iFamily® is registered trademark of TL elektronik.
sModern® is registered trademark of TL elektronik.

All information in this User's manual is subject to change without prior notice.

Table of Contents







Table of Contents 2
Record of revision 5
Accessories and Packing List 9
Limited warranty 10
General description..... 11
 About this Guide 12
 Integra iFamily® Connection 12
 Compatibility of Integra Glass Cockpits..... 13
 Explanation of Possible Connections..... 13
 Back up System Recommendation 14
 Explanation of Priority setting for Data Sharing 15
 INTEGRA Glass Cockpit..... 16
 Capabilities..... 17
 Power Supply 17
 Theory of Operation..... 18
BASIC OPERATION 19
 Operation terminology 19
 Turning the INTEGRA ON..... 19
 Turning the INTEGRA OFF 19
 INTEGRA Control Panel 20
 Knobs 21
 Buttons and Labels..... 21
 Data Port 22
 Battery Installation..... 27
 SD card Installation..... 29
 Brightness..... 30
 Information about Battery 31
 Warning Signals..... 32
INTEGRA Operation 33
 General navigation through INTEGRA screens 34



Description of EFIS screen	35
Description of function – EFIS	36
Navigation Section.....	42
Description of VOR	43
Description of LOC.....	45
Description of GPS	47
NAV/HDG	51
Heading Set.....	52
Boresight	52
NAV Source.....	53
ALT BUG	54
IAS BUG.....	54
HDG	55
Barometer adjustment	56
Integra Menu	57
Brightness.....	57
Checklist.....	58
Statistic for EFIS.....	59
Entertainment	60
Other setting.....	60
Configuration of Integra	65
Enter to setup	65
Power Off.....	66
About.....	66
Autopilot	67
Adjusting the AP	69
Steps for configuration and switching on the AP from off-state	70
How to turn off the AP.....	73
How to readjust the AP	74
Setting the AP via External Button	75
Menu Entertainment.....	77
Option Movie	79

Option Music.....	81
Option Flight Data	82
Option Exit.....	82
Abbreviations	83
Technical Parameters	85

Record of revision

Revision	Revision Date	Description	ECO#	Insertion date	By
PrA	13.04.2013	Initial version			Hovorka

-  **WARNING:** This product is not TSO approved as a flight instrument, therefore, the manufacturer will not be held responsible for any damage caused by its use.
-  **WARNING:** The altitude calculated by the INTEGRA is geometric height above mean sea level and could vary significantly from altitude displayed by pressure altimeters in aircraft.
-  **CAUTION:** The 3D Terrain Map supplied with INTEGRA relies on GPS data, this system is subject to changes which could affect the accuracy and performance of the INTEGRA 's 3D Terrain map. The electronic chart is an aid to navigation and is designed to facilitate the use of authorized government charts, not replace them. Land and water data is provided only as a general reference to your surroundings. The positional accuracy of the land and water data is not of a precision suitable for use in navigation and it should not be used for navigation. Only official government charts and notices contain all information needed for safe navigation and, as always, the user is responsible for their prudent use.
-  **CAUTION:** The Terrain feature is for supplemental awareness only. The pilot/crew is responsible for all terrain and obstacle avoidance using information not provided by the INTEGRA 3DTerrain feature.
-  **CAUTION:** Although the INTEGRA series are precision electronic Navigation AIDs (NAVAID), any NAVAID can be misused or misinterpreted and therefore become unsafe.
-  **CAUTION:** Use the INTEGRA at your own risk. To reduce the risk of unsafe operation, carefully review and understand all aspects of this User's Manual and the Flight Manual Supplement, and thoroughly practice basic operation prior to actual use. When in actual use, carefully compare indications from the INTEGRA to all available navigation sources, including the information from other NAVAIDS, visual sightings, charts, etc. For safety, always resolve any discrepancies before continuing navigation.

-  **CAUTION:** The INTEGRA - series does not contain any user-serviceable parts. Repairs should only be made by an authorized TL-elektronik service center. Unauthorized repairs or modifications could void your warranty and authority to operate this device under FCC Part 15 regulations.
-  **NOTE:** It is the pilot's responsibility for initial missed approach guidance in accordance with published procedure. The unit may not provide correct guidance until established on a defined leg.
-  **NOTE:** This device complies with Part 15 of the FCC limits for Class B digital devices. This equipment generates, uses, and can radiate radio frequency energy and, if not installed and used in accordance with the instructions, may cause harmful interference to radio communications. Furthermore, there is no guarantee that interference will not occur in a particular installation.

If this equipment does cause harmful interference, the user is encouraged to try to correct the interference by relocating the equipment or connecting the equipment to a different circuit than the affected equipment. Consult an authorized dealer or other qualified avionics technician for additional help if these remedies do not correct the problem. Operation of this device is subject to the following conditions:

- (1) This device may not cause harmful interference, and this device must accept any interference received, including interference that may cause undesired operation.
- (2) The INTEGRA display lenses are coated with a special antireflective coating which is very sensitive to skin oils, waxes and abrasive cleaners. It is very important to clean the screen using an eyeglass lens cleaner which is specified as safe for anti-reflective coatings and a clean, lint-free cloth.

To obtain accessories for your INTEGRA, please contact your TL-elektronic dealer. Help us better support you by completing our on-line registration form today! Registration ensures that you will be notified of product updates and new products and provides lost or stolen unit tracking. Please, have the serial number of your unit handy, connect to our web site (www.tl-elektronic.com) and look for our Product Registration link on the home page. TL elektronik is fully committed to your satisfaction as a customer. If you have any questions regarding the INTEGRA, please contact our customer service department.

Accessories and Packing List

The INTEGRA represents TL electronics' continued commitment to providing you with the most advanced technology available today — in an accurate, easy-to-use design suitable for all of your flying needs. Unless otherwise specified within this manual, the term “INTEGRA” applies to the TL-6524, TL-6724, TL-6624, TL-6824, TL-6560, TL-6760, TL-6660 and TL-6860.

Before installing and getting started with your new system, please ensure that your package includes the following items. If any parts are missing or are damaged, please contact your TL-elektronic dealer.

Standard Package:

- INTEGRA Unit
- Installation Rack
- Accessories
- User and Configuration manual
- CD with software and Installation Manual.
- Warranty Card

Optional Accessories:

- Internal back-up Battery
- SD card with 3D Terrain

Your aviation maintenance specialist should perform the installation and configuration of your new INTEGRA unit. The INTEGRA should be secured in the installation rack with the proper wiring connections. Be ready to answer any questions that your maintenance specialist could have about the installation such as location of antennas or any connections to other equipment in the panel.

Limited warranty

The TL elektronik company warrants this product to be free from defects in materials and manufacture for three years from the date of purchase. TL elektronik will, at its sole option, repair or replace any components that fail in normal use. Such repairs or replacement will be made at no charge to the customer for parts or labour. The customer is, however, responsible for any transportation costs. This warranty does not cover failures due to abuse, misuse, accident or unauthorized alteration or repairs.

THE WARRANTIES AND REMEDIES CONTAINED HEREIN ARE EXCLUSIVE AND IN LIEU OF ALL OTHER WARRANTIES EXPRESS OR IMPLIED OR STATUTORY, INCLUDING ANY LIABILITY ARISING UNDER ANY WARRANTY OF MERCHANTABILITY OR FITNESS FOR A PARTICULAR PURPOSE, STATUTORY OR OTHERWISE. THIS WARRANTY GIVES YOU SPECIFIC LEGAL RIGHTS, WHICH MAY VARY FROM STATE TO STATE.

IN NO EVENT SHALL TL ELEKTRONIC BE LIABLE FOR ANY INCIDENTAL, SPECIAL, INDIRECT OR CONSEQUENTIAL DAMAGES, WHETHER RESULTING FROM THE USE, MISUSE, OR INABILITY TO USE THIS PRODUCT OR FROM DEFECTS IN THE PRODUCT. SOME STATES DO NOT ALLOW THE EXCLUSION OF INCIDENTAL OR CONSEQUENTIAL DAMAGES, SO THE ABOVE LIMITATIONS MAY NOT APPLY TO YOU.

To obtain warranty service, call the TL elektronik Customer Service (+420 49 548 23 92) for a returned merchandise tracking number. The unit should be securely packaged with the tracking number clearly marked on the outside of the package and sent freight prepaid and insured to a TL elektronik warranty service station. A copy of the original sales receipt is required as the proof of purchase for warranty repairs. TL elektronik retains the exclusive right to repair or replace the unit or software or offer a full refund of the purchase price at its sole discretion. SUCH REMEDY SHALL BE YOUR SOLE AND EXCLUSIVE REMEDY FOR ANY BREACH OF WARRANTY.

General description

Thank you for purchasing the TL-elektronik INTEGRA. This section provides some important cautionary information and general usage instructions for this manual.

Before You Fly

We strongly recommended that you read this entire guide before attempting to use the INTEGRA in an actual flying situation. Additionally, we encourage you to spend time on the ground familiarizing yourself with the operation of the product. While first learning to use the instrument in the air, we recommend you have a backup pilot with you in the aircraft. Finally, we encourage you to keep this manual in the aircraft with you at all times. This document is designed to give you quick access to information that might be needed in flight.

 **CAUTION:** In a flying situation, it is the pilot's responsibility to use the product and the guide prudently.

OEM Installations

If your INTEGRA is installed by an OEM aircraft producer, you may find that you are unable to access some menus and settings. Some TL-elektronik distributors customize various areas of the INTEGRA firmware to maintain a consistent pilot experience and minimize INTEGRA information issues across a large number of installations. Currently, OEMs can customize access levels to the following settings on TL-elektronik systems: EMS SENSOR setup menu, fuel calibration, trim calibration, flaps calibration, GPS/NAV setup menu, screen configurations, data logging, and checklists/data panels. OEM distributors have the option of customizing some or all of these areas. Please contact your aircraft's manufacturer if you have any questions about how your unit has been customized.

 **WARNING:** TL-elektronik Avionics' products incorporate a variety of precise, calibrated electronics. Except for replacing the optional internal backup battery in INTEGRA -based products per the installation guide, our products do not contain any field/user-serviceable parts. Units that have been found to have been taken apart may not be eligible for repair under warranty. Additionally, once a TL-elektronik unit is opened up, it will require calibration and verification at our factory before it can be considered airworthy.

⚡ WARNING: The INTEGRA is permanently supplied by the aircraft's power supply. Therefore, it is necessary to install a fuse to act as protection against a power surge. This will protect against the risk of fire and resulting damage to the INTEGRA and/or aircraft.

About this Guide

This guide serves two purposes. The first is to help you configure and get acquainted with the INTEGRA's many functions. The second is to give you quick access to vital information. For detailed technical and installation information, please refer to the INTEGRA Installation Guide. In the electronic (.PDF) version of this manual, page and section references in the [Table of Contents](#) and elsewhere act as hyperlinks taking you to the relevant location in the manual. The latest version of this manual may be downloaded from our website at www.tl-elektronik.com.

Integra iFamily® Connection

The TL elektronik iFamily® BUS

If you have multiple TL elektronik products in your aircraft, they can be networked together via the TL elektronik **iFamily®** BUS. Units networked via **iFamily®** have the ability to share information with each other. Any product's data can then be viewed on any other screen in the **iFamily®** network. For example, an EFIS has the ability to display engine monitor information if it is connected to an EMS TL-6724.

The **iFamily®** systems allows you to connect autopilot servos and remote compass

ⓘ NOTE: That the failure of a unit in an iFamily® network may cause the loss of some or all data shared between units. In the example below, if the connected EMS TL-6724 were to fail, the EFIS/EMS would no longer be able to behave as an engine monitor.

Compatibility of Integra Glass Cockpits

New Integra Glass Cockpits with 9" displays have same software architecture as Integra Glass Cockpits with 7" displays. This means that functionality is identical for both mentioned product lines. The product lines are fully compatible with each other. Practically this means that for example EFIS TL-6524 can be connected to TL-6760 via **iFamily®** BUS. Also HW solution for connection is identical for both product lines; the connectors are identical; so for example you can easily replace your TL-6624 with TL-6660 without any modification of harness.

Here is table describing part numbers for Integra Glass Cockpits:

Functionality	Part Number for Integra with 7" display	Part Number for Integra with 9" display
EFIS & EMS	TL-6624	TL-6660
EFIS	TL-6524	TL-6560
EMS	TL-6724	TL-6760
Remote Display	TL-6824	TL-6860

Explanation of Possible Connections

i **NOTE:** This section does not contain all possible connections. Introduction of new Integra Glass Cockpits with 9" displays to market bring many new possible connections.

Here are a few Instrument connection Possibilities

If you connect TL-6524 with TL-6724 you will be able to share the screen data between the two instruments

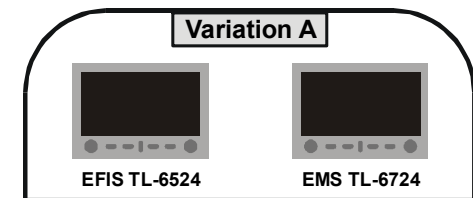

If you connect TL-6524 with TL-6824 you will be able to read the same data on TL-6824 as you have on TL-6524

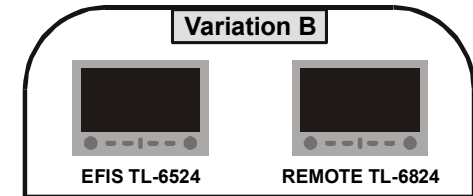

If you connect TL-6724 with TL-6824 you will be able to read the same data on TL-6824 as you have on TL-6724

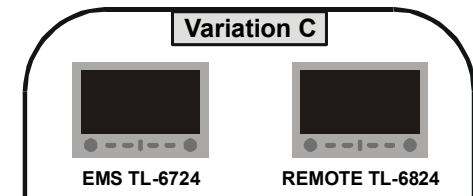

If you connect TL-6624 with TL-6824 you will be able to read the same data on TL-6824 as you have on TL-6624

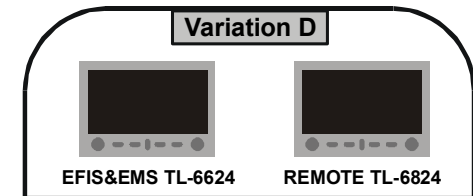

Back up System Recommendation

We recommend this configuration for safe panel system redundancy: **TL 6524 and 6624**
In the case of instrument failure flight information will be available on the second instrument.

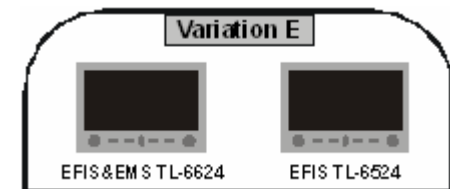

Explanation of Priority setting for Data Sharing

The priority for Data Sharing is set in Setup Mode, separately for EMS data (in EMS Setup Mode) and for EFIS data (in EFIS Setup Mode). Although Setup Mode is subject of Configuration Manual, we explain priority setting of Data Sharing here to make you understand whole Data Sharing function at once.

EFIS Data Sharing:
Low Priority set
EMS Data Sharing:
Low
or
High Priority set

EFIS Data Sharing:
High Priority set

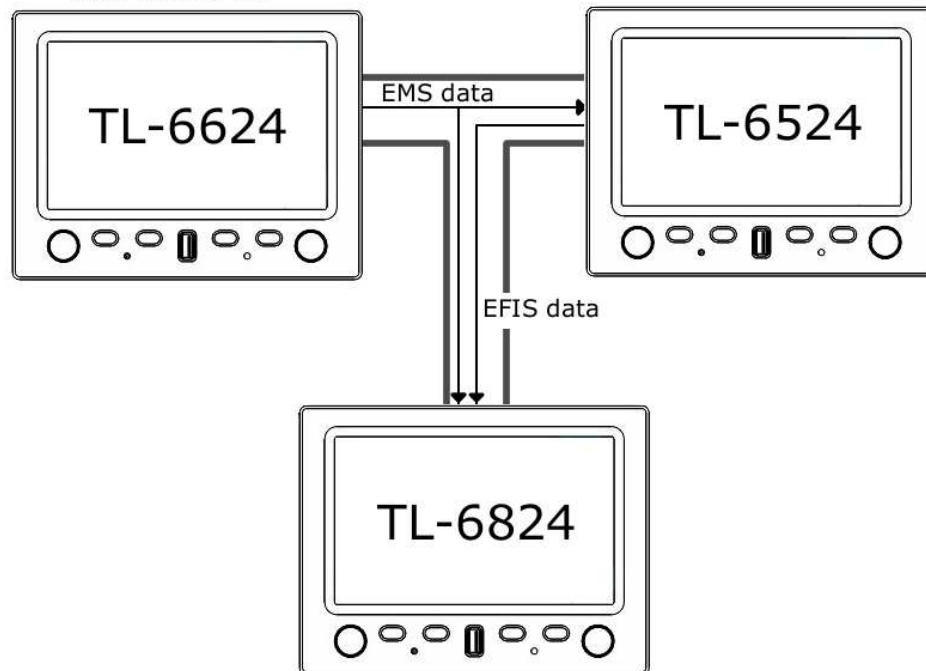

Data Sharing “Priority” means importance of specific data (EFIS or EMS data), which the Integra is sending to bus.

For example:

The picture on right side shows three Integra units connected by bus. Arrows linking the units express actual flow of information. Connection of TL-6624 and TL-6524 creates EFIS data redundancy, because both units have internal sensors for measuring EFIS data. The both units send EFIS data to the bus, because their EFIS Data Sharing is On (EFIS Data Sharing is not set to Off). EFIS data from TL-6524 takes priority over EFIS data from TL-6624 on the bus, because TL-6524 is set to higher EFIS Data Priority than TL-6624. Therefore TL-6824 receives EFIS data from TL-6524. But TL-6624 and TL-6524 display their own EFIS data. Own data of the Integra always takes priority over data from the bus.





Because TL-6524 has no inputs for measurement of EMS data, the only way to display EMS data on the unit is to receive EMS data from TL-6624 via the bus. Therefore priority for TL-6624 EMS Data Sharing could be set to Low or High. There is no difference because this unit is only EMS data source.

TL-6824 hasn't got Data Sharing Setting. It only receives data available on the bus according to priority setting of data sources previously described. The only way to disable receiving and displaying data in standard screen is to unplug the bus from TL-6824.

NOTE: Explanation of priority setting is also applicable for Integra units with 9” displays, please see section Compatibility of Integra Glass Cockpits on page 13.

INTEGRA Glass Cockpit

Before operation the INTEGRA, please check to see if there are any parts damaged. If there are damaged components please contact TL-elektronik or your TL-elektronik dealer immediately. The INTEGRA requires a Remote Compass and GPS Receiver to provide a full range of functions.

-  **WARNING:** Obstacle clearance is not assured in 3D Terrain or Highway in the Sky (HITS) approach mode.
-  **CAUTION:** If any display unit in the chain is inoperable, the display units will not be able to share information. The pilot must account for this down-graded mode of operation and expect data will not transfer between displays.
-  **NOTE:** It is highly desirable to provide each display unit with its own connection to each source of data if possible. This increases the redundancy of the system, and reduces the amount of lost function in the event a display unit becomes inoperative.
-  **NOTE:** Most, but **not all** data contained within this manual is accurate. Some differences may be observed when comparing the information in this manual to other instrument generation models.

Before You Fly

We strongly recommended that you read this entire guide before attempting to use the INTEGRA in an actual in-flight situation. Additionally, we encourage you to spend time on the ground familiarizing yourself with the operation of the product. While first learning to use the instrument in the air, we recommend you have a backup pilot with you in the aircraft. Finally, we encourage you to keep this manual in the aircraft with you at all times. This document is designed to give you quick access to information that might be needed in flight.

-  **NOTE:** While in-flight, it is the pilot's responsibility to use this product and this guide prudently.

Capabilities

The INTEGRA's robust design enables the use of a wide range of engines and sensors. You may configure the INTEGRA system to meet your monitoring requirements. The INTEGRA visual and audio warning systems give you immediate notification of any potential problem that might otherwise go unnoticed. The accurate and reliable solid-state sensors of the INTEGRA provide essential information with a user-friendly interface.

Power Supply

The INTEGRA requires between 10 and 30 volts DC for operation and should be connected to an external backup power supply with keep-alive voltage. The INTEGRA can be turned on during engine start.

The INTEGRA can be ordered with an optional internal Li-poly backup battery which allows the instrument to continue to operate in the event of an external power failure. This lithium-polymer battery is rechargeable and its charge is maintained by the INTEGRA.

If the always-on circuit is connected, the INTEGRA continues to charge its internal battery even if the instrument is turned off. This ensures a full charge for your internal emergency battery.

Under normal conditions, the internal battery should have a voltage between 11.1 and 12.6 volts. A new fully charged internal battery is rated for a minimum 30 minute of normal operation with the INTEGRA. If the INTEGRA has switched to its internal back up battery due to external power loss, it is advisable that you land your aircraft as soon as possible.

i **NOTE:** Battery life is dependent on for example, the brightness of the display and number of sensors which are battery-powered etc.

Theory of Operation

The primary flight instruments on your EFIS display are generated using a group of calibrated sensors. All of them are solid state – that is, there are no moving parts. These sensors include accelerometers, which measure forces in three directions; rotational rate sensors, which sense rotation of all three axis; pressure transducers for measuring air data; and magnetometers on all three axis for measuring magnetic heading.

i **NOTE:** This product is intended for experimental and Light Sport Aircraft categories and is not approved for installation in Certified Aircraft.

BASIC OPERATION

Operation terminology

Term “select” in the context of Integra operation in this manual means this sequence of operation steps:

1. Highlight described menu option by rotating the knob.
2. Press the knob.

When the manual says e.g. “Press button “Yes”, it means press the button with label “Yes” displayed on screen above the button.

Turning the INTEGRA ON

Press the right-hand knob to turn the Integra on and wait until the green backlight goes out.

 **NOTE:** The other knob and buttons are disabled when the INTEGRA is Shut Down.

Turning the INTEGRA OFF

To turn off the INTEGRA and place it in Shut Down Mode

3. Press the right-hand knob.
4. Select **Power Off**

 **NOTE:** All settings and calibrations will be stored when the INTEGRA is Powered Off.

INTEGRA Control Panel

The picture below shows Integra Control Panel. Integra Control Panel includes 2 knobs, 6 buttons and USB Data Port.

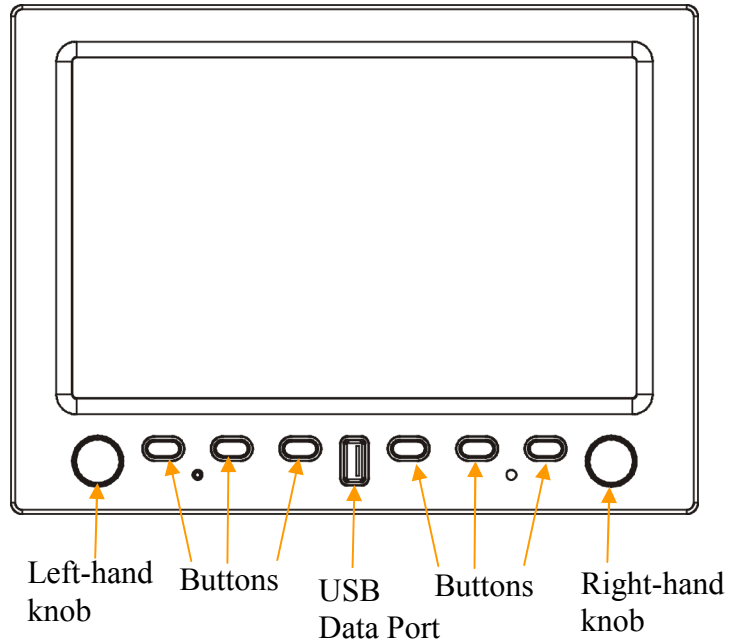

Knobs

Control of all menus is really easy and simple. The two knobs have two interfaces - **press** and **rotate**. These provide particular menu options on different pages, and are used to

- cycle between screens
- scroll through menus
- adjust instrument parameters and settings

i **NOTE:** ALT bug, HDG bug and Press baro - you can use fast rotate, the units will change more quickly.

Buttons and Labels

The **Button** and **Knob Labels** will appear as white on black writing in the default mode.

The **Labels** will be highlighted once the control panel is engaged by pressing a button or turning a knob.

The **Prompt Labels** turn red to match any urgent notice appearing on the screen.

Data Port

The INTEGRA allows the pilot to enter checklists, flight plans, general information and update firmware through the USB port. This data must be verified for accuracy by the pilot prior to flight.

Access to Data Port function

If you want to work with data from an external source, plug USB flash drive into the USB port. Allow 10 seconds for the Integra to read the drive. Press the right-hand knob to enter the menu and select Enter Setup. When prompt “Are you sure you want to enter to setup?” appears, press button “Yes”. Now the Integra is in Setup Mode. Button label “Data Port” is displayed. Press that button. Menu Data Port will appear containing the following:

- **Menu DATA PORT**
 - *Import Checklist*
 - *Import Configuration*
 - *Export Configuration*
 - *Export Flight Data*
 - *Export Service Log*
 - *Update Firmware*

i **NOTE:** If you can't see “Data Port” button label in Setup Mode, check correct USB flash drive connection.

Import Checklist	You can create your checklist on your computer and you can transfer this data into the Integra.
Import Configuration	You can create your configuration on your computer and you can copy these settings to the Integra.
Export Configuration	You can export your configuration from the Integra to your USB flash drive.
Export Flight Data	You can export your flight data from the Integra to your USB flash drive.
Export Service Log	You can export your service log from the Integra to your USB flash drive.
Update Firmware	You can update the firmware of Integra.

Import Checklist

The first step: Integra Demo PC application

To create or edit checklist:

Installed Integra Demo PC application is required. You can obtain Integra Demo from TL-elektronic web site. (Products->LSA->category EFIS&EMS Integra->TL-6x24*->Downloads-> Demo PC application.)

- 1) Connect USB flash drive to your personal computer. Run Integra Demo, press right mouse button over Integra buttons area. The context menu will appear:

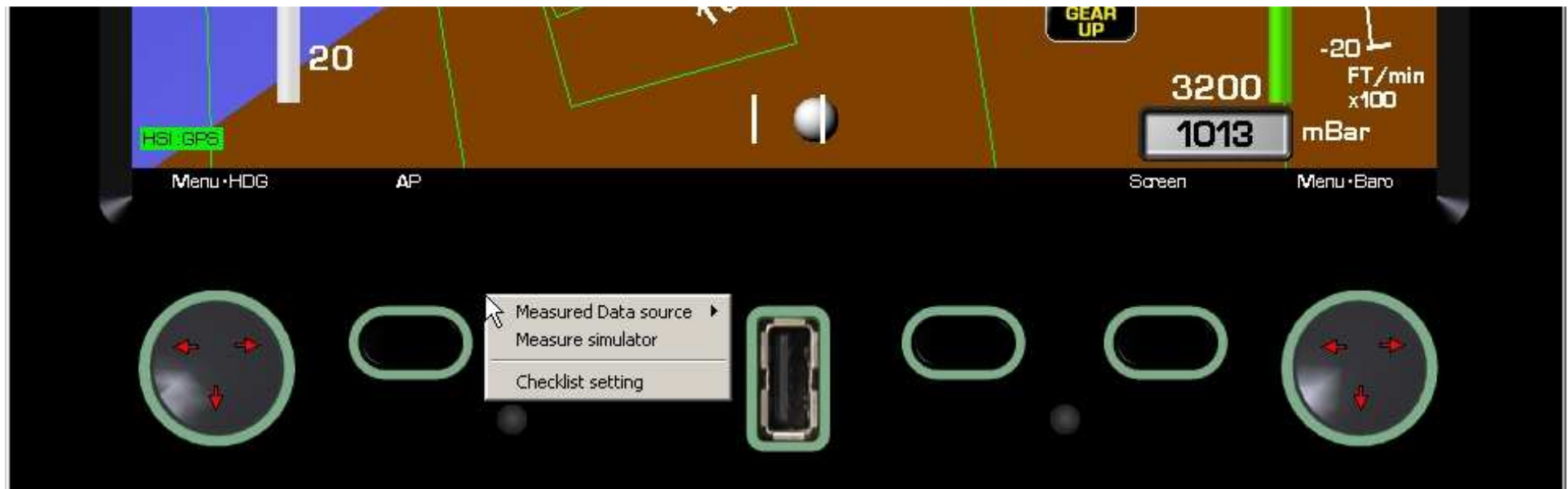

*Demo PC application is same for all versions of the Integra

2) Select Checklist setting from context menu. The Checklist setting window will appear:

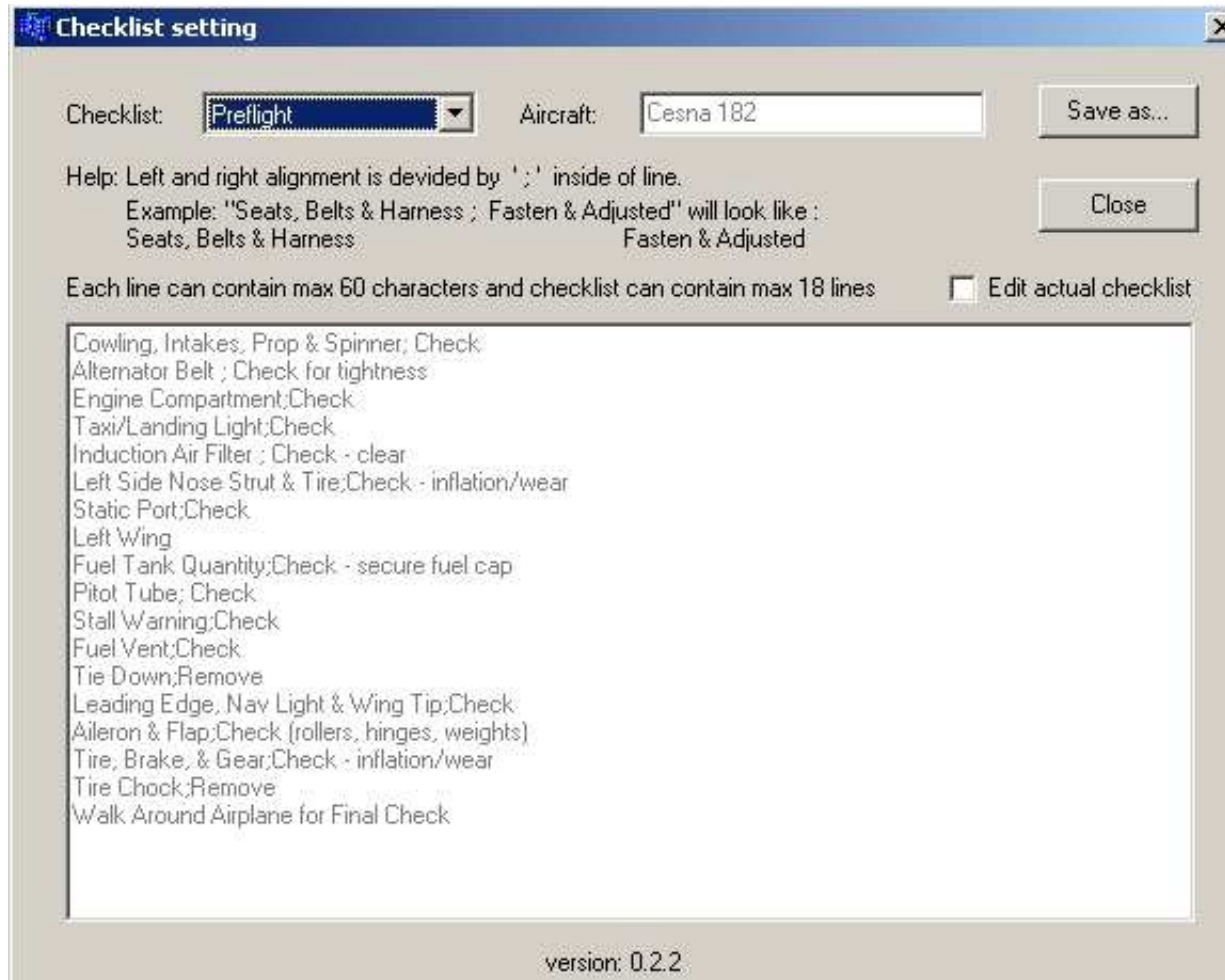

- 3) From drop-down list “Checklist” choose desired checklist for editing. Select check box “Edit actual checklist” to edit chosen checklist. Now text of appropriate checklist changed from gray to black and you can edit it. After you’ll be satisfied with content of all checklists, select button “Save as...” to save complete set of checklists at once. In “Save as” window choose root directory of your USB flash drive.

The second step: Uploading checklists to the Integra

- 4) Plug a USB flash drive into the USB port of the Integra. Allow 10 seconds for the Integra to read the drive. Press the right-hand knob to enter the menu and select Enter Setup. When prompt “Are you sure you want to enter to setup?” appears, press button “Yes”. Now the Integra is in Setup Mode. Button label “Data Port” is displayed. Press that button. In menu Data Port select Import Checklist.



Update Firmware

The first step: PC operation

- 1) Create the “tle” directory and then create the “update” directory inside the “tle” on your USB flash drive. So the path will be: X:\tle\update
- 2) Copy the file “fwu.tls” to the UPDATE (on your USB flash drive).

The second step: Uploading firmware to the Integra

- 3) Plug USB flash drive into the USB port of the Integra. Allow 10 seconds for the Integra to read the drive. Press the right-hand knob to enter the menu and select Enter Setup. When prompt “Are you sure you want to enter to setup?” appears, press button “Yes”. Now the Integra is in Setup Mode. Button label “Data Port” is displayed. Press that button. In menu Data Port select Update Firmware.
- 4) Integra will display: "Are you sure you want to update firmware?" Press “yes”. There will be another warning message: "During operation do not power off instrument!!!" Press “OK”. The display shows you “Firmware update – Please wait while download is finished” while the firmware is loading. Do not touch any button or knob while the firmware is loading. The time for loading the firmware differs with every next firmware. The firmware loading time varies from each software upgrade package.

-  **CAUTION:** Ensure sustaining voltage during updating - if during updating fails the electric power supply, the Integra can be damaged.
-  **CAUTION:** Keep the USB flash drive connected with the Integra during updating.
-  **CAUTION:** This data port is intended only to be used with USB flash drive. Do not try to connect it to another USB device.

Battery Installation

⚡ WARNING: Before installing battery turn off INTEGRA.

- Remove INTEGRA from mounting rack.
- Unscrew the battery cover located on the right side of the unit.
- After screw out carefully take off a sheet metal cover.
- The cable is attached to a holder of the battery with the baling wire – this wire must be removed.

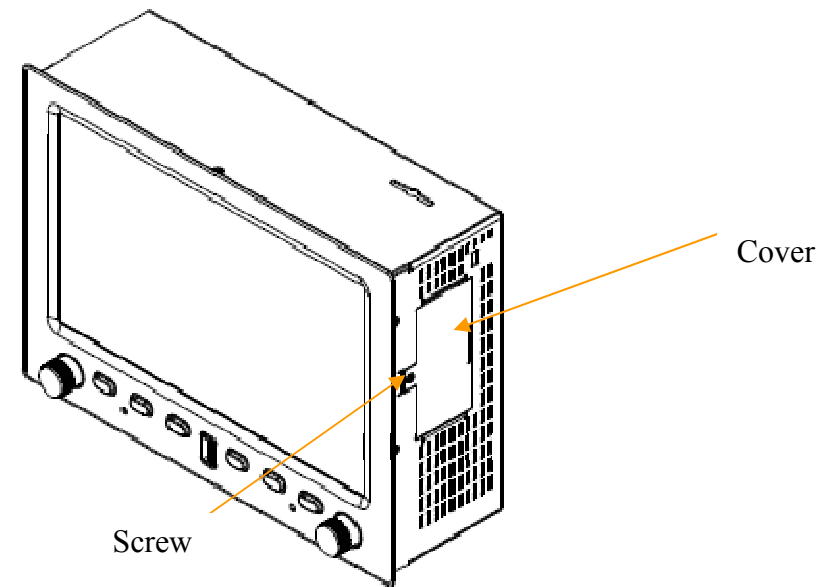

- The battery is intended to be used only with the INTEGRA. The Battery has a one connector to link it to INTEGRA and two lugs which nicely lock it to the battery holder.
- Connect the cables located in the battery holder to the Back-up battery. The connector is notched so you cannot connect this cable incorrectly to the battery.
- Put the battery in to the INTEGRA battery holder so that the lugs fit into the round holes on the INTEGRA battery holder and **the connector must be on the top. You should obey this to prevent damage of the battery cable caused by sharp edges of the battery holder.**

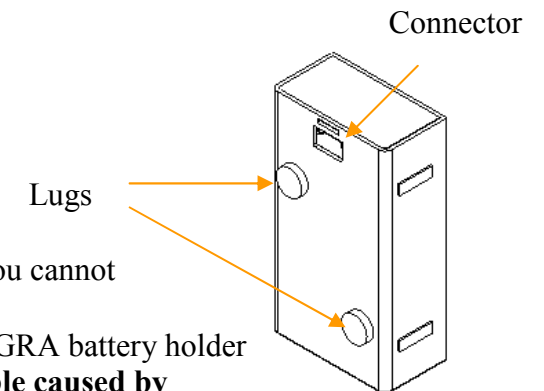



Cable for connecting INTEGRA with battery.

Before screwing the cover on make sure that the battery is not protruding and is properly placed in the INTEGRA battery holder. Then screw battery cover back on to INTEGRA.

⚡ WARNING: To not apply pressure to the battery while re-installing the cover.

Correct battery installation in Integra

Incorrect battery installation in Integra

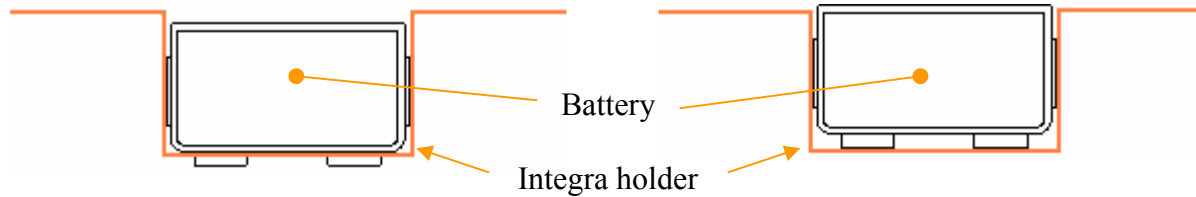

SD card Installation

- Turn off INTEGRA.
- Remove INTEGRA from mounting rack.
- The slot for the SD card is situated on the top right side of INTEGRA.
- Now insert SD card into the slot so that the front SD card label is facing you and the label text is upside-down.
- Carefully press the card down until you feel it click.
- The SD is now installed in the INTEGRA.

- If you want to remove the SD card, first carefully press down and the card will eject. You can then safely remove the card from the INTEGRA.

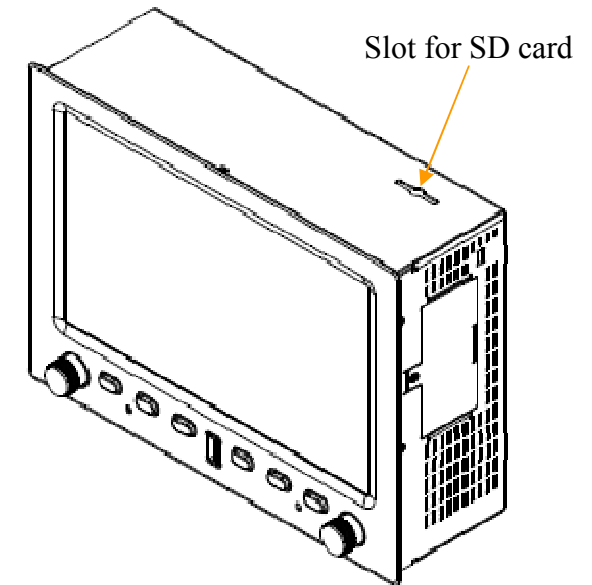

Brightness

This controls the brightness of the LCD.

Press the right-hand knob and select Brightness. Rotate the knob to choose the level of brightness.

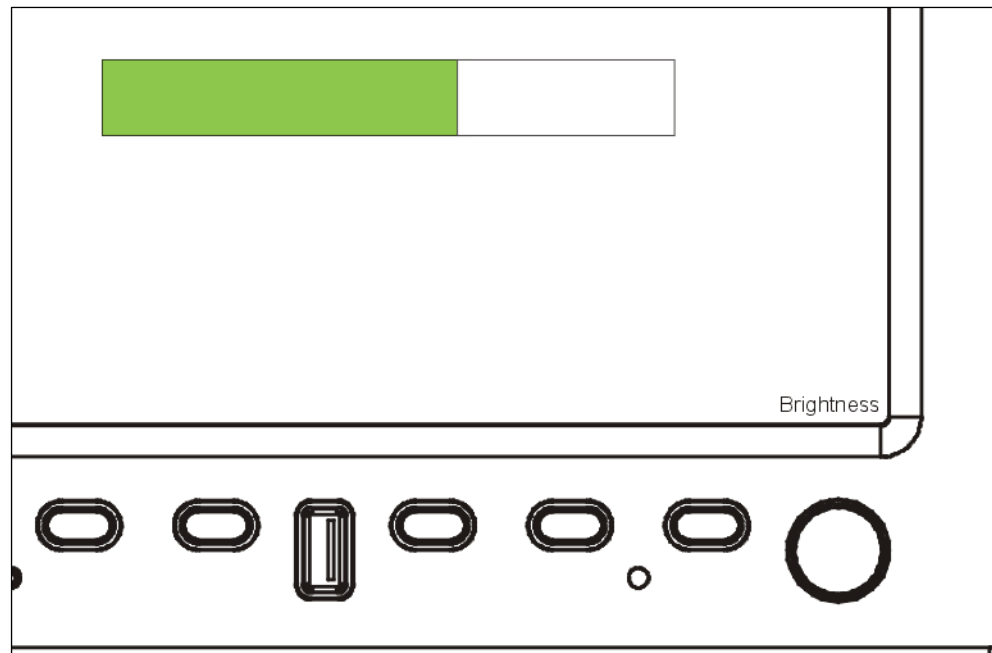

The green strip specifies level of brightness

- i NOTE:** This function is available only if DIMMER SOURCE CONTROL is set to MANUAL (Press the right-hand knob, select Enter Setup. When prompt “Are you sure you want to enter to setup?” appears, press button “Yes”. Now the Integra is in Setup Mode. Press the right-hand knob, select Other Setting & Calibration. New menu will appear. There select Backlight Control, then select Dimmer Source Control. Finally select Manual. Now manual setting of display brightness is enabled.

Information about Battery

The INTEGRA utilizes a Lithium Polymer battery with the following characteristics:

Storage Temperature	-20°C to 60°C (-4°F to 140°F)
Recharge Life	300 - 400 cycles

A Lithium Polymer battery operates without a memory effect, meaning it can be recharged before it is completely discharged without affecting the energy capacity.

⚠ CAUTION: Keep the Battery Pack connector away from metallic objects.
Any tampering of the cell within the INTEGRA Battery Pack is strictly forbidden in any circumstances.
Do not immerse in water.
Do not place near a heat source.
Never heat the battery nor throw into a fire.
Do not expose the battery pack to temperatures in excess of 60°C (140°F).

⚠ CAUTION: The Integra Battery Pack is intended for use only with Integra Products.

Disposal Procedures:

For Ecological and Environmental reasons it is advisable to consult with local authorities for disposal regulations.

Warning Signals

GEAR UP	Landing Gear is retracted
GEAR DOWN	Landing Gear is extended
GEAR TRANSIT	Landing Gear is retracting or extending or there is a problem with the Landing Gear
CNPY	Canopy is open
CO₂	A dangerous quantity of CO ₂ is in the cockpit
ERR	Information on measured quantity is not available
EXTERNAL POWER	INTEGRA is connected to an external power supply
BATTERY POWER: - - - min	INTEGRA's is power supply from battery

i NOTE: Landing gear position is shown by status indicators. Indicator should be used only as a backup. It is provided to give the pilot a single location to view the aircraft configuration. The Gear Lights located on the aircraft instrument panel should be viewed before landing. The INTEGRA can provide a gear up voice warning if the following functions are monitored: Gear Position and Airspeed. If Airspeed drops below a programmed level (set for your aircraft) and the Landing Gear is not down you will get a voice warning.

INTEGRA Operation

General navigation through INTEGRA screens

If you press button “Screen”, label of the button will change to “Next” and label of the right-hand knob will change to “Screen”.

If you press the button again (or rotate the right-hand knob), INTEGRA will display next screen.
Take look at the picture.

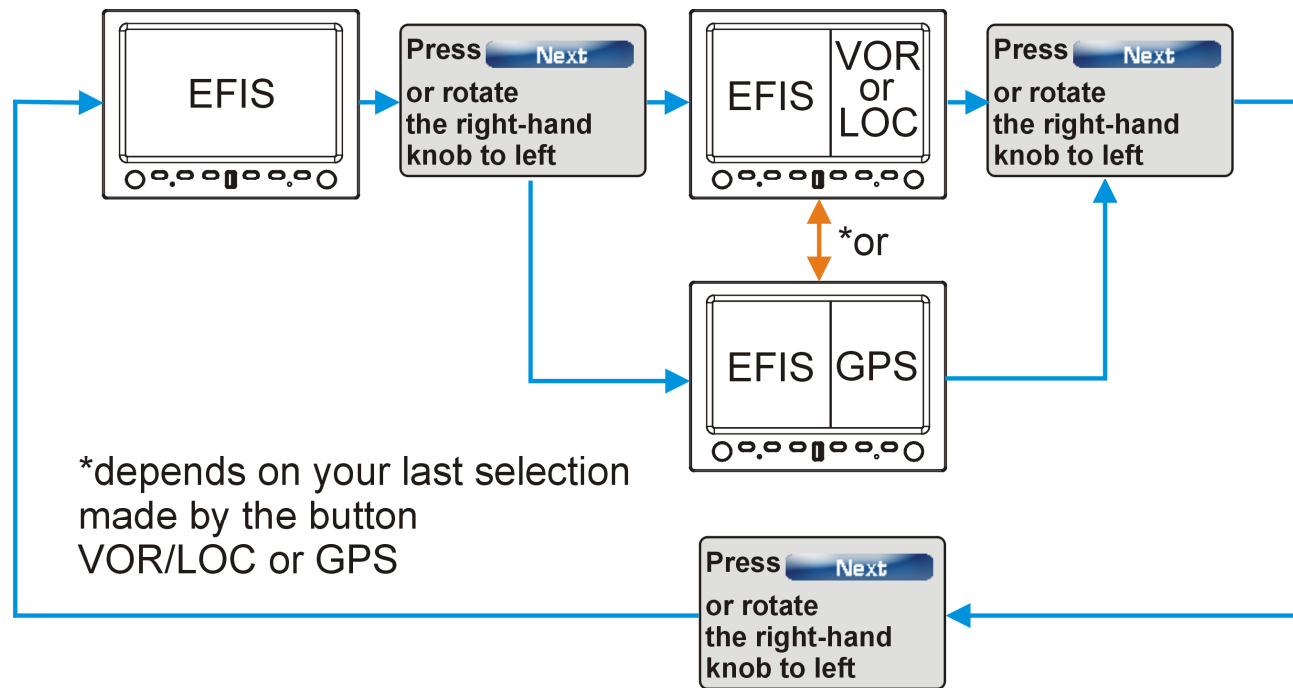





Integra Operation

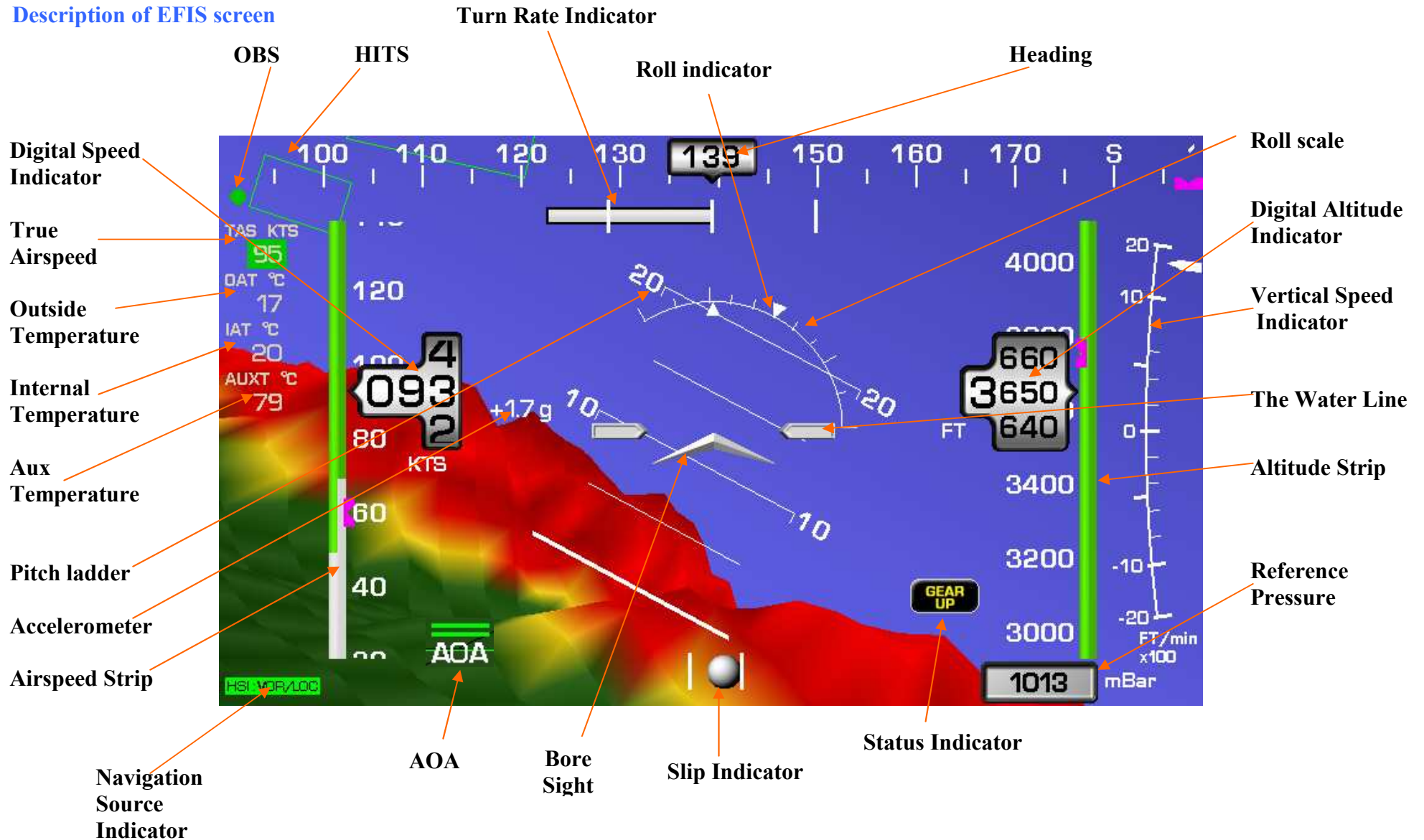

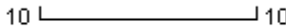

Screen description of complete EFIS

Description of EFIS screen

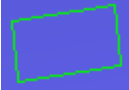

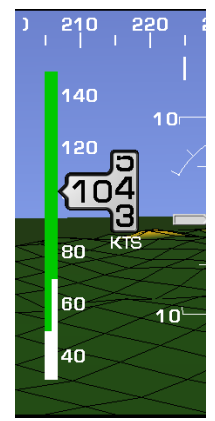
Description of function – EFIS

Bore Sight	The position of the Arrow indicator or Bore Sight Indicator can be controlled by turning the left-hand knob. If the Arrow turns yellow for few seconds, that indicates the Arrow is in the centre position.	
Digital speed indicator	Shows you actual speed.	
Accelerometer	Vertical Acceleration Indicator.	
Pitch ladder	Is shown by white horizontal lines with a 10 degree scale.	
Navigation Source Indicator	Shows you actual source of navigation.	
AOA	Angle of Attack Indicator.	
HITS	Highway In The Sky. Virtual boxes which are displayed in airspace. They are tracing the flight path predetermined by GPS.	

Airspeed strip	<p>Indicates the airspeed</p> <ul style="list-style-type: none">- To define the airspeed limits, see Configuration Manual-section EFIS Range and Limits- The lower white end – indicates minimum flight speed in landing configuration V_{S0}- The lower green-white border – indicates $V_S =$ Stall Speed- The upper green-white border – indicates maximum speed for flaps extension V_{FE}- The yellow-green border – indicates maximum structural cruising speed V_{NO}- The red-yellow border – indicates never exceed speed V_{NE} <p>The speed is also displayed numerically in the numerical airspeed indicator. The units display knots, kilometres, miles – as determined by the user.</p>	
Slip Indicator	<p>The slip/skid ball works much like a standard mechanical gauge. It is a visual representation of lateral acceleration. If the ball is within the two vertical lines, then you are in coordinated flight.</p>	
Reference pressure	<p>There is the reference pressure box underneath the altitude strip in millibar, torr or inHg. Rotate the right-hand knob to set the value then confirm by pressing the Knob to Set Press.</p>	
The Water Line	<p>Is indicated by two silver oblong bars.</p>	

Indicates the aircraft altitude based on static air pressure. There are three colours on the altitude strip these colours match the colours displayed by 3D terrain.

Green - parallel to the barrel pointer indicates that the aircraft is 100 meters or more over terrain.

Yellow - indicates that within a 5km range there is terrain within 100m below the aircraft.

Red - indicates that within a 5km range there is terrain that is higher than the aircraft's flight level. The pilot must alter aircraft altitude to avoid collision.

Altitude Strip



The altitude strip scrolls beside the numerical readout and arrow. The digital simulation of an numerical altimeter scroll up and down giving an indication of of direction and movement. Thousands of feet/meters are displayed using large numbers to the left while hundreds of ft/m are shown in smaller numbers to the right.

NOTE: The altitude strip only has a 5km range in front of the aircraft.





3D Terrain Color display

This picture is a logical scheme of the color configuration of the 3D terrain map in comparison to aircraft altitude.

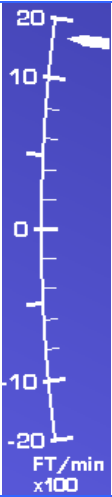

Displayed color of terrain	Altitude of terrain in 5km range is:
Red	higher than aircraft's altitude
Yellow	within 100m below aircraft's altitude
Green	100m or lower below aircraft's altitude

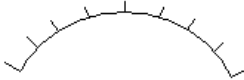
i NOTE: This information will only be shown with the installation of 3D Terrain.

Vertical Speed Indicator	The VSI scale is at the right-hand side of the screen next to the altimeter strip Vertical speed in m/s or ft/min (as determined by user). – and is indicated by a Grey Vertical Flag.	
Digital Altitude Indicator	Shows you actual altitude.	
Roll scale	120 degrees of roll, each line indicates 15 degrees variation	
Turn Rate Indicator		
OBS	Omni-Bearing Selector. When using VOR/LOC as Navigation source the OBS is shown as a green ball on the Heading Tape. When GPS is used as a source the ball is blue and when Navigation source is OFF, OBS is not displayed. Pilot sets the OBS by rotating appropriate knob (external knob or knob of the Integra).	

Heading

Stabilized heading tape and digital readout. Located at the top of the EFIS page, the heading indicator functions much like a standard slaved directional gyro. North, East, South, and West directions are labelled on the tape, “N,” “E,” “S,” and “W,” respectively. The digital readout displays your current heading, while the surrounding tape scrolls beneath its arrow. You may set a magenta bug on this tape as a heading reminder. Like a conventional gyro-stabilized magnetic compass, magnetic heading reacts immediately to turn rate so that heading changes are reflected immediately.



Roll indicator

Two little arrows in the middle of the Roll Scale.



Navigation Section

- i NOTE:** VOR/LOC information will be only accessible when INTEGRA is connected to Garmin SL30 navigation receiver.
- i NOTE:** GPS information will be only accessible when INTEGRA is connected to a GPS receiver.

Switching between Navigation screens

Following description presumes that INTEGRA is switched to display any split screen. If it is not, please press button “Next” repeatedly until a split screen is displayed (see section General navigation through INTEGRA screens on page 34).

By pressing the button (labeled ”VOR/LOC” or “GPS”) you can switch between VOR/LOC and GPS screens.

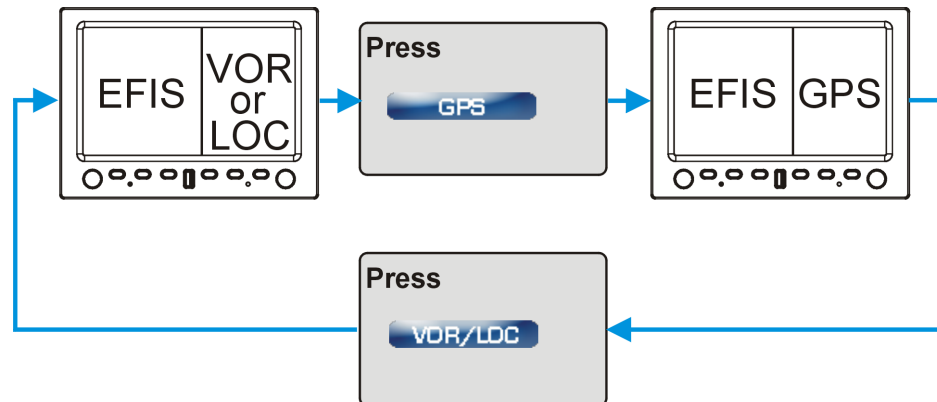

Description of VOR

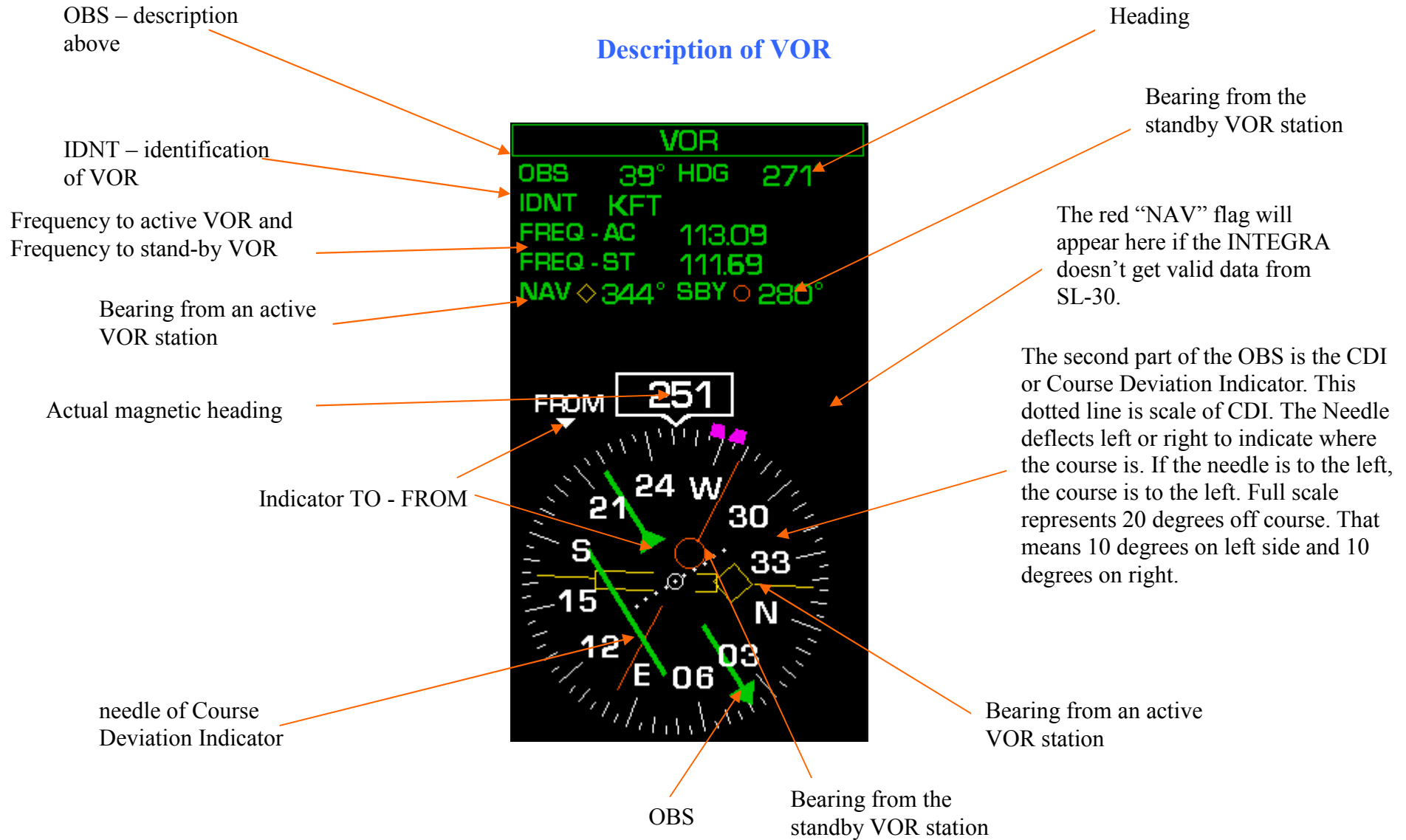

Navigation Section

Description of VOR

All data are valid



Green label VOR indicates that VOR is valid.

OBS and CDI is not valid



Label NAV-NO ACTIVE indicates that OBS and CDI is **not** valid. Needle of CDI is not displayed. It means that SL-30 is connected and it's sending data to the Integra, but data are incomplete. **So, you can't rely on OBS.** Other data are valid.

Only magnetic heading is valid



If SL-30 failed or its cable connection, the red NAV-NO DATA label will appear. **Only valid information is actual heading, because Remote compass sends actual heading information not SL-30.** OBS arrow will be pointing to actual heading.

Description of LOC

OBS – description above

IDNT – identification of VOR

Frequency to active VOR and Frequency to stand-by VOR

Bearing from an active VOR station

Actual heading

Indicator TO - FROM

The second part of the OBS is the CDI or Course Deviation Indicator. The dotted line is scale of CDI. The Needle deflects left or right to indicate where the course is. If the needle is to the left, the course is to the left. Full scale represents 5 degrees off course. That means 2.5 degrees on left side and 2.5 degrees on right.

LOC

OBS 39° HDG 271°

IDNT KFT

FREQ - AC 113.09

FREQ - ST 111.69

NAV ◇ 344° SBY ○ 280°

FROM 25.1

24 W 30

5 15 12 03

E 06 N

Heading

Bearing from the standby VOR station

Glide Slope Indicator. Yellow arrow in picture is just pointing to ideal glide slope determined in half of full scale. Full scale represents 1.4 degree. If actual glide slope is out of range, the yellow arrow will disappear and red "GS" flag will appear above scale.

Bearing from an active VOR station

Bearing from the standby VOR station

OBS

All data are valid



Glide Slope Indicator. If glide slope is in recommended range, yellow arrow will appear to indicate current glide slope. Full scale of the range represents 1.4 degree. Mark in half of scale represents ideal glide slope.

Current Glide Slope is out of recommended range



Glide Slope Indicator. Red flag GS indicates that current glide slope is out of recommended range.

Description of GPS

Waypoint identifier

Bearing To Waypoint (BTW) indicator

Distance to waypoint this can be expressed in Knots, miles or kilometers –see section Units in Configuration Manual.

Altitude

Ground speed

Track indicator. This indicates your direction over the ground as reported by the GPS. It can differ from magnetic heading, when crosswinds are present.

OBS. Omni-Bearing Selector

GPS

ID: LOWK OBS 163°

BTW ◊ 199°

DTW 2886.50 NM

ALT 3499 FT

SPD 121 KTS

TRK 166° HDG 271°

158

50 NM

“GPS” label will be changed to yellow „GPS-NO ACTIVE“ label if the Integra doesn’t get data about flight plan from GPS receiver. If the Integra completely loses signal from GPS receiver, label will change to red „GPS-NO DATA“.

This field shows the value for the Heading bug set by the pilot.

Actual magnetic heading

Track indicator

Course Deviation Indicator (CDI). When a flight plan is active in the GPS, the CDI indicates how far to the left or right of your selected ground course you are.

Bearing To Waypoint (BTW)

Scale indicator. It determines what scale CDI is using. See picture on page 49.

All data are valid



All data are valid.

OBS is indicating bearing adjusted by pilot.

BTW is indicating next destination waypoint and DTW determines its distance.

Other displayed data have same meaning as data described on previous page.

Invalid data: ID, OBS, CDI, Scale indicator



Flight plan is not available. Waypoints in GPS receiver are not set or GPS receiver is sending incomplete data due its settings. Check settings of the GPS receiver.

Invalid data displayed by the Integra:

- ID
- OBS
- BTW
- DTW
- CDI
- Scale Indicator

Other displayed data have same meaning as data described on page 45 and page 46.

Only valid data: Magnetic Heading, Heading Bug



GPS receiver is set as **CONNECTED** in Setup Mode, but it is not sending data. That means GPS receiver is not connected actually or GPS receiver failed or its cable connection failed.

Only valid data displayed by the Integra on Navigation screen:

actual magnetic heading

pre-set Heading Bug

OBS aligns with Heading Bug.

Scales of CDI for GPS

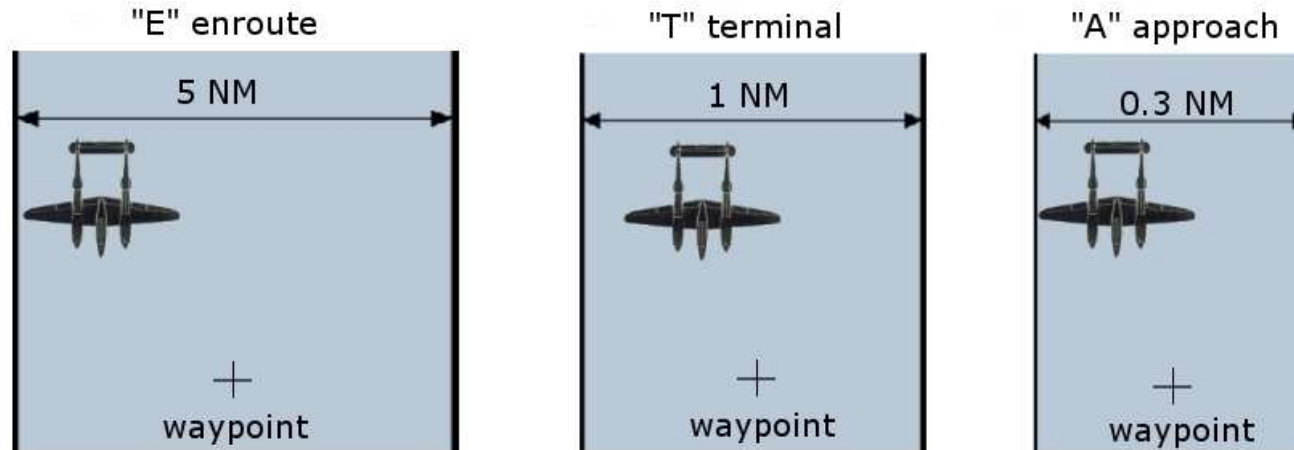

NAV/HDG

For enter to navigation just press the left-hand knob with label **Menu•HDG** Turn the knob to scroll through the menu titles then press the knob when the title is highlighted. Select the **Back Arrow** symbol to return to the previous menu or screen. Each Menu has an **EXIT MENU** title at the bottom. Press to select and exit the menu.

- **Menu•HDG**
 - *Heading Set*
 - *Bore Sight*
 - *Nav Source*
 - *ALT Bug*
 - *IAS Bug*
 - *Exit Menu*

Heading Set

Is used to set a magenta bug to current heading value displayed by digital readout on Heading Tape.

Boresight

Is used to compensate for a weight displacement due to an excessive payload in order to maintain a level horizontal flight path

Look at the pictures – take note position boresight against the water line. When the boresight is at one line with water line, the boresight is yellow for a little time. When you move with the boresight, its colour is magenta.

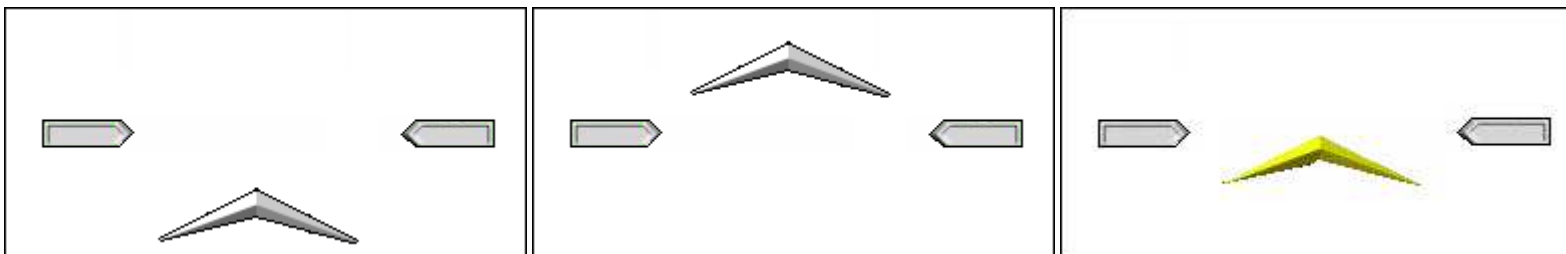

Pictures with different position of boresight

Press the left-hand knob and select Boresight. When is displayed “Set weight” you can rotate with the knob and set up boresight.

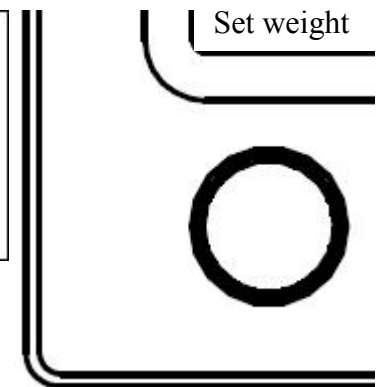

NAV Source

In this menu you can choose which source of navigation you want use. All this navigations are described above.

- **Menu NAV Source**
 - *Off*
 - *VOR/LOC*
 - *GPS*

If you choose one of the sources of navigation above label NAV/HDG is displayed a little legend, which source of navigation is select.

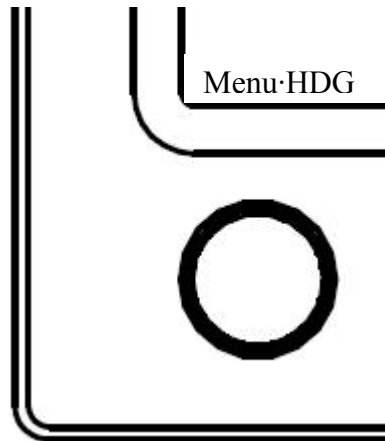

Source navigation is OFF

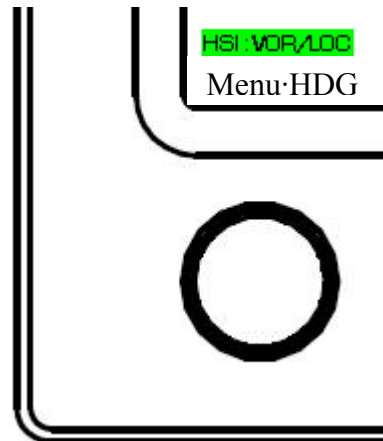

Source navigation is VOR/LOC

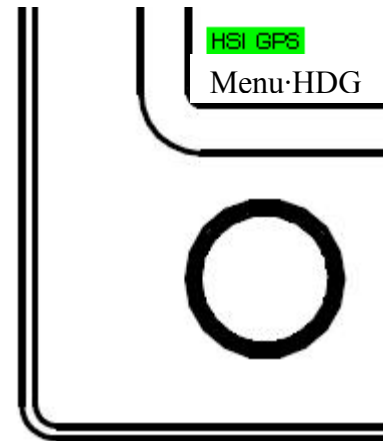

Source navigation is GPS

BUGS

Bugs are little helping signs indicating parameters of Altitude, Airspeed and Heading as you wish. Altitude and Airspeed bug can be set from Menu•HDG (see page 55 for description for Heading bug setting). If you select ALT Bug or IAS Bug option, appropriate table (pictured below) will appear to indicate currently adjusted value of Altitude or Speed Bug. You can change the value by rotating left Menu•HDG knob. If you want to accept current value, press the left-hand knob. If you want to disable the bug, press button Disable. If you want to revert to previous setting, press button Cancel.

BUGS



ALT BUG Altitude sign

IAS BUG Speed sign

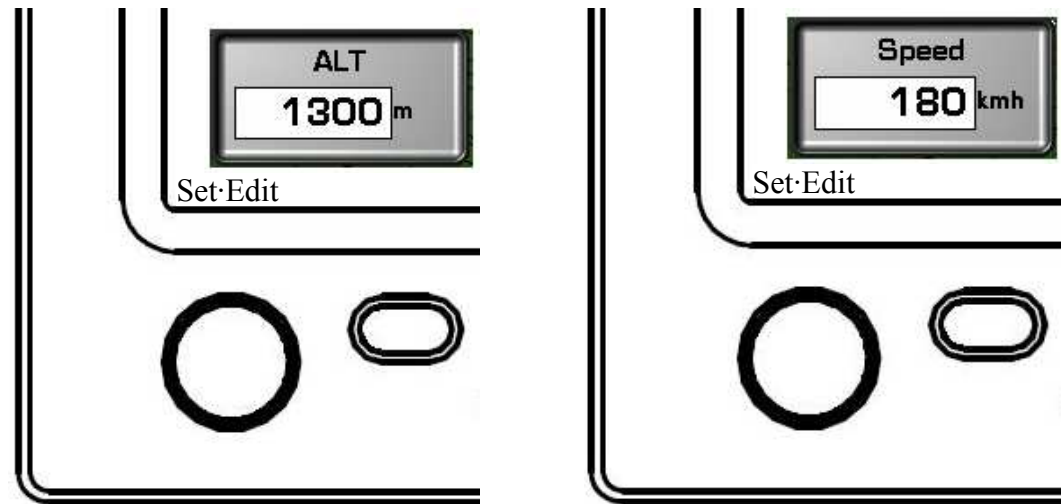

BUGS settings

HDG

Set headings is doing in default menu. Just twist with the left-hand knob and a Heading table is displayed on screen. Knob label Set·Edit and button labels Disable and Cancel will appear.

If you want to accept current value, press the left-hand knob. If you want to disable the bug, press button Disable. If you want to revert to previous setting, press button Cancel.

Heading can be set in default menu. Just rotate the left-hand knob and Heading table will be displayed on screen. Knob label Set·Edit and button labels Disable and Cancel will appear. If you want to accept current value, press the left-hand knob. If you want to disable the bug, press button Disable. If you want to revert to previous setting, press button Cancel.

The main instrument display shows a heading scale at the top with a bug set at 200 degrees. A speed scale on the left has a bug set at 180 km/h. An altitude scale on the right has a bug set at 1400 m. The display also shows TAS 198 km/h, OAT 17 °C, IAT 20 °C, AUXT 79 °C, and a heading of 173. A gear transient indicator is visible at the bottom.

BUG is set on 200 deg

BUG is set on 1400 m

BUG is set on 180 km/h

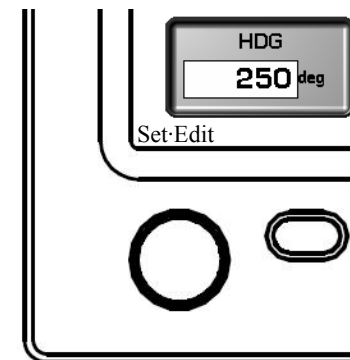

Barometer adjustment

Atmospheric pressure could be set easily by rotating of the right-hand knob. If you rotate the knob, the Baro table will be displaying actual adjusted pressure. You can set actual value by press of the knob. Or you can just wait a few seconds and new value will be used.

If you press button QFE, current altitude will be set to zero. This option is usually used, when the aircraft is on runway and you want to altitude be referenced to level of the runway.

If you press button 1013.25, current altitude will refer to sea level.



Integra Menu

To enter menu just press the right-hand knob with the Menu Label. Turn the knob to scroll through the menu titles then press the knob when the title is highlighted. Select the **Back Arrow** symbol to return to the previous menu or screen. Each Menu has an **EXIT MENU** title at the bottom. Press to select and exit the menu.

- **Menu•Baro**
 - *Brightness*
 - *Checklist*
 - *Statistic*
 - *Entertainment*
 - *Other Setting*
 - *Enter Setup*
 - *Power Off*
 - *About*
 - *Exit Menu*

Brightness

Instruction is therein before (page 30).

Checklist

The Checklist is your most valuable tool to insure a safe flight. It is easy to miss a critical step in any phase of the flight (latch the canopy drop the landing gear, select the mains, etc.). Each checklist is determined by your aircraft make and model and is installed into the INTEGRA to be easily recalled by the pilot at a moment's notice.

You can edit this checklist on your computer and then you can copy via USB port on INTEGRA. Follow instructions in section Data Port (page 22).

- **Menu CHECKLIST**

- *Preflight check*
- *Before start engine*
- *Starting engine*
- *Engine runup*
- *Before take off*
- *Landing*
- *After landing*
- *Shut down*

Preflight check	instructions for a preflight check
Before start engine	instructions on what is needed to check before starting your engine
Starting engine	the procedures to start the engine
Engine run-up	a list of what is required during engine run-up
Before takeoff	a list of what needs to be checked before a takeoff
Landing	instruction about what is necessary before landing
After landing	a list of what must be done after landing
Shut down	instructions on what is needed to be done before shutting down

Cesna 152	
Preflight Checklist	
Cowling, Intakes, Prop & Spinner	Check
Alternator Belt	Check for tightness
Engine Compartment	Check
Taxi/Landing Light	Check
Induction Air Filter	Check - clear
Left Side Nose Strut & Tire	Check - inflation/wear
Static Port	Check
Left Wing	
Fuel Tank Quantity	Check - secure fuel cap
Pitot Tube	Check
Stall Warning	Check
Fuel Vent	Check
Tie Down	Remove
Leading Edge, Nav Light & Wing Tip	Check
Aileron & Flap	Check (rollers, hinges, weights)
Tire, Brake, & Gear	Check - inflation/wear
Tire Chock	Remove
Walk Around Airplane for Final Check	

For example: Checklist of Preflight
check for Cesna 152

Statistic for EFIS

Statistics provides a summary of EFIS Information

ALTITUDE MIN	Minimum altitude
ALTITUDE MAX	Maximum altitude
SPEED MIN	Minimum speed
SPEED MAX	Maximum speed
VSI MIN	Minimum VSI
VSI MAX	Maximum VSI
ACCELERATION MIN	Minimum acceleration
ACCELERATION MAX	Maximum acceleration

If Statistics are displayed, the basic menu is changed.

HIDE – statistic screen is closed

DELETE VALUES – you can erase statistic values

If you press Delete values, INTEGRA ask you, if “Are you sure you want to delete statistic?” If you press “Yes” the statistic will be deleting. If you press “No” the statistic will be conserved.

Entertainment

The Entertainment feature gives you access to the internal media player.
See section Menu Entertainment on page 77.

Other setting

In this menu you can turn on or turn off 3D terrain. 3D terrain show you ground below you in 3D picture.

i **NOTE:** 3D terrain is optional function.

- **Menu OTHER SETTING**

- *3D terrain ON*
- *3D terrain OFF*
- *Highway ON*
- *Highway OFF*
- *Towing Menu ON*
- *Towing Menu OFF*

3D terrain ON	turn on 3D terrain
3D terrain OFF	turn off 3D terrain
Highway ON	turn on HITS
Highway OFF	turn off HITS
Towing Menu ON	turn on Towing Menu
Towing Menu OFF	turn off Towing Menu

3D terrain ON/OFF

3D terrain shows you ground below you in 3D picture.

Highway ON/OFF

Highway shows you square on display thereby show you way.

Towing Menu ON/OFF

This feature is useful specially for towing aircraft. Pilot can visually monitor the glider during towing. This is possible due to switching the INTEGRA for displaying video from rear aircraft camera.

How to turn Towing Menu ON or OFF:

Press the right-hand knob and select option Other Setting, then select Towing Menu OFF or Towing Menu ON.

If Towing Menu is ON, button label “Hor/Cam” will be displayed. Remember that “Hor/Cam” button is not displayed in EMS and EFIS full screen. Switch the INTEGRA to any split screen to display “Hor/Cam” button. See next page for graphic representation of availability of “Hor/Cam” button for individual screens. Description for functionality of “Hor/Cam” button could be found on page 64.

Towing Camera View



Screens where "Hor/Cam" button is displayed

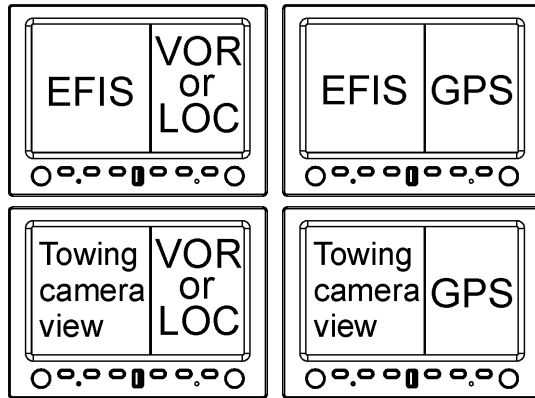

Screen where "Hor/Cam" button is not displayed

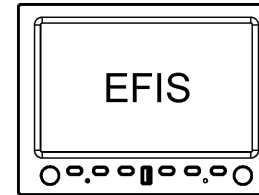

The picture clearly explains functionality of “Hor/Cam” button. “Hor/Cam” button controls switching between four displaying modes shown in the picture.

**Artificial Horizon displayed
Maneuver Indicators hidden**



**Artificial Horizon displayed
Maneuver Indicators displayed**

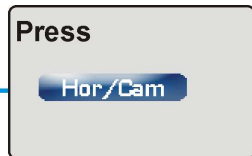
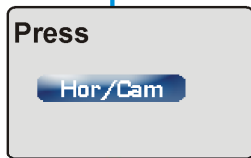
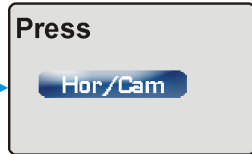

**Towing Camera View displayed
Maneuver Indicators displayed**



**Towing Camera View displayed
Maneuver Indicators hidden**

Configuration of Integra

Enter to setup

In setup you can edit many parameters as you wish such as units, configuration & sensors, limits, other setting & calibration and external devices. Press the right-hand knob and select Enter Setup. When prompt “Are you sure you want to enter to setup” appears, press button “Yes”.

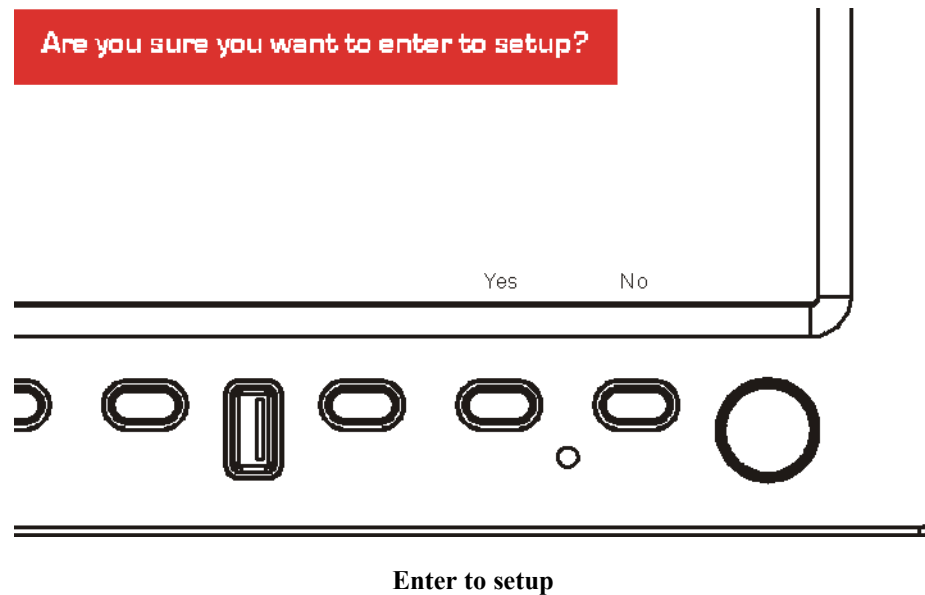

i **NOTE:** More about SETUP menu you can find in CONFIGURATION MANUAL.

Power Off

You can turn the Integra off by pressing the Power Off button. You have 20 seconds to cancel this operation. Just press any knob or button.

i NOTE: When you power up the Integra and the Integra starts to shut off, press any button and it is necessary to disconnect the Main Switch Signal. (Menu Setup– Other Setting & Calibration – Main Switch Control).

About

There you can find the information about your Integra.

HW version	Information about the hardware version
GUI version	Information about the graphics interface
Release	Information about the firmware version

Autopilot
(Optional function)

Autopilot

About

The Integra Autopilot (referenced below as the AP) offers roll (aileron), pitch(elevator) and yaw(rudder) axis control. The number of axes, which can be controlled by AP, is depending on your purchased Activation Key; as well as variety of navigation abilities of AP. See Price list for available AP Activation keys and their features.

	Full set of primary flight (engine) instruments	HDG, TRK, horizontal Nav (radio or GPS)	ALT hold and change	Control Wheel Steering	Horizontal GPS Steering	Dedicated Control	HDG, TRK, NAV ALT, pre-arm	Vertical Speed hold	ALT, VS, TRK, HDG pre-selected	Vertical GPS Steering	Vertical NAV (Radio or GPS)	2-axis control	3-axis control
Integra with Premium Activation Key	●	●	●	●	●							●	
Integra with Silver Activation Key	●	●	●	●	●	●	●	●	●	●	●	●	
Integra with Gold Activation Key	●	●	●	●	●	●	●	●	●	●	●	●	●

Main differences between Activation Keys:

Premium

Aircraft is stabilized in flight altitude and heading. Moreover the AP features ability of following flight path specifying only heading. This flight path is determined by navigation source (GPS, VOR or LOC). The AP with Premium Key cannot follow flexible flight altitude, which is determined by navigation source.

The AP controls 2 axes: roll and pitch.

Silver

Aircraft is stabilized in flight altitude and heading. Moreover the AP features ability of following flight path specifying flight altitude and heading. This flight path is determined by navigation source (GPS, VOR or LOC).

The AP controls 2 axes: roll and pitch.

Gold

Aircraft is stabilized in flight altitude and heading. Moreover the AP features ability of following flight path specifying flight altitude and heading. This flight path is determined by navigation source (GPS, VOR or LOC).

The AP controls 3 axes: roll, pitch and yaw. The additional yaw axis control provides optimum performance during heading corrections controlled by the AP.

i NOTE: AP is no substitute for the pilot remaining in full control of aircraft. AP is only addition in piloting of the aircraft. You should not engage in other activities that reduce your attention to piloting.

Thanks to simple but genius engineering solution using servos with magnetic clutch, you can seize control of the aircraft immediately whenever your action is needed. Precise setting of servos slipping is required due to setting of the right amount of transmitted torque. See Configuration Manual for setting servo slipping.

Adjusting the AP

Due to clever design of user interface you can set very easily parameters of the AP.

i NOTE: Execute the steps below in defined sequence if the AP is in off-state. In that case the AP will begin to control flight after you finished last step in sequence. If the AP is already in on-state and you want to reset its parameters then you should follow How to readjust the AP. On-state of the AP is indicated by “AP FN” button label next to the left-hand knob label in EFIS or EFIS/EMS divided screen.

Steps for configuration and switching on the AP from off-state

Step 1: Access to function of the AP

Switch the Integra to EFIS Screen or any split screen. In EMS full screen, the AP button label isn't displayed.

If the Towing Menu is ON and the Integra is displaying split screen (EFIS/EMS, EFIS/VOR...), you won't be able to access the AP setting via the Integra buttons. But if the AP is already activated, it will remain activated, but you won't be able to access its setting via the Integra buttons.

The Integra displaying modes in which setting of the AP is accessible



EFIS screen when Towing Menu is OFF or ON



EFIS/GPS screen when Towing Menu is OFF

Step 2: Selecting of controlled axis/axes

In this part you'll set the axis/axes which the AP controls.



Press button "AP".

New button labels appear:



Press the appropriate button for choosing controlled axis or axes.

Both

The AP controls both axes: Roll and Pitch axis. Aircraft is keeping up determined heading and altitude. Target heading **and** altitude could be determined by one of three modes. Selecting of desired mode is subject of next step.

Roll

The AP controls only Roll axis. Aircraft is keeping up determined heading. Target heading could be determined by one of three modes. Selecting of desired mode is subject of next step.

Pitch

The AP controls only Pitch axis. Aircraft is keeping up determined altitude. Target altitude could be determined by one of three modes. Selecting of desired mode is subject of next step.

Cancel

It cancels setting the AP.

Step 3: Selecting of navigation controls

In this step you'll choose mode for controlling previously selected axis/axes.

i NOTE: If you selected "Both" in previous step, same mode for controlling both axes will be used by AP. This means that you can't select e.g. Stabilization mode for Roll and Bugs mode for Pitch.

After you selected axis/axes for AP operation, new button labels appear:



Stabilization

The AP will be following heading and/or altitude that was actual in the moment in which you pressed Stabilization button.

Bugs

The AP will be following heading and/or altitude determined by Heading bug and/or Altitude Bug.

NAV

The AP will be following heading and/or altitude determined by selected navigation source (VOR or GPS). If you want to change navigation source, press the left-hand knob and select option Nav Source. There you can choose desired navigation source.

Cancel

It cancels setting the AP.

After you've finished this step, the AP will be controlling the aircraft according to selected axis/axes and its navigation controls. ON-state of the AP is indicated by button label AP FN:



How to turn off the AP

This part assumes that the AP is already in on-state.



Press button AP FN.

The button label has changed to AP OFF:



Press button AP OFF. Now the AP is in off-state.

Off-state of the AP is indicated by button label AP:



How to readjust the AP

This part assumes that the AP is already in on-state.

This part describes changing of controlled axis/axes and navigation controls of the AP.

Change of controlled axis



Press button AP FN.



Then press button Axis.

The options are same as in step Selecting of controlled axes:



After selecting desired option, the button label has changed back to AP FN:



The AP is controlling the aircraft according to just adjusted axis/axes and previously adjusted navigation control.

Change of navigation controls



Press button AP FN.



Then press button Control.

The options are same as in step Selecting of navigation controls:



After selecting desired option, the button label has changed back to AP FN:



The AP is controlling the aircraft according to just adjusted navigation control and previously adjusted axis/axes.

Setting the AP via External Button

External button makes your setting of the AP more comfortable. By press of this button you can deactivate the AP, activate the AP with its previous settings, deactivate the AP for a while by keeping the button pressed etc. See Configuration Manual for further info.

Ask your aircraft maintenance specialist for built in the button with appropriate and handy location. Recommended place for external button is on yoke (control column) or on central panel.

option of Menu External Button		action of the button (note: Before any deactivation[temporary or permanent] of the AP performed by the external button, the AP has to be activated by the AP buttons on the Integra at first.)	
		press (press and immediate release)	holding down
Hold On Function Enable			
	Deact. Only is set	The AP is deactivated. Activation of the AP must be performed by the AP buttons on the Integra.	The AP is temporarily deactivated. After release of the button, the AP will follow the last configuration.
	Prev.Act. & Deact is set	The AP is activated with the last configuration. Next pressing will deactivate the AP.	The AP is temporarily deactivated. After release of the button, the AP will follow the last configuration.
	Stab.Act & Deact. is set	The AP is activated and the AP will hold current altitude and heading.	The AP is temporarily deactivated. After release of the button, the AP will hold current altitude and heading.
Hold On Function Disable			
	Deact. Only is set	The AP is deactivated. Activation of the AP must be performed by the Integra buttons.	<i>no reaction</i>
	Prev.Act. & Deact is set	The AP is activated with the last configuration. Next pressing will deactivate the AP.	<i>no reaction</i>
	Stab.Act & Deact. is set	The AP is activated and the AP will hold current altitude and heading.	<i>no reaction</i>

Menu Entertainment

Menu Entertainment serves for access to multimedia functions of the Integra. You can listen to your favourite music or watch movies. These multimedia possibilities of the Integra enrich passengers' experience from flight.

To enter Entertainment Menu:

Press the right-hand knob, select option Entertainment from menu. When prompt "Do you want to enter to Entertainment?" appears, press button Yes.

Now the Integra is displaying Entertainment Screen:

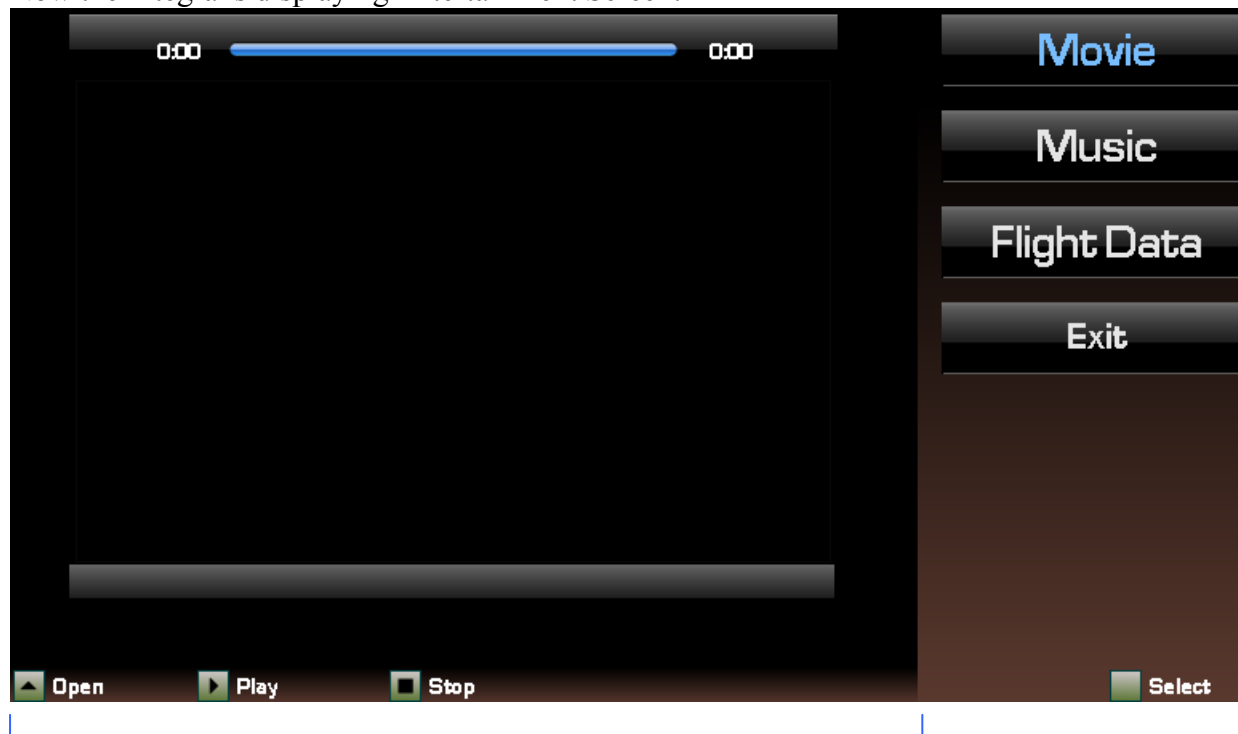

Part for displaying chosen option

menu

Handling the menu

Rotate the right-hand knob for scrolling through menu. Select desired function by pressing the right-hand knob.

i NOTE: If you want to open multimedia file on plugged SD card, you won't be able to have connected USB flash drive. That's because the Integra will check primarily for connected USB flash drive. Then if USB flash drive isn't found, the Integra will check for SD card. And if SD card is not either plugged, then the Integra will load files from internal memory.

Option Movie

Probably you want to watch some movie on your USB flash drive or SD card. To do this, follow these instructions:

Press the left-hand knob "Open". Window will appear for selecting video file. There you can scroll through currently viewed directory by rotating the left-hand knob. Names of displayed subdirectories are closed in square brackets []. Playable files are displayed with postfix ".3gp".

If you want to move down to some subdirectory, choose desired subdirectory and press the left-hand knob.

If you want to move up to the parent directory, choose item [..] and press the left-hand knob.

For replaying desired video file, just choose appropriate item and press the left-hand knob. The Integra should be replaying your video now.

For maximizing video presentation to full screen press button "Maximize". For returning to previous screen, press any button.

i NOTE: The Integra only supports .3gp video format. Other files-video of different format or any other data aren't displayed in Select video file window.

elapsed time of video

remaining time of video

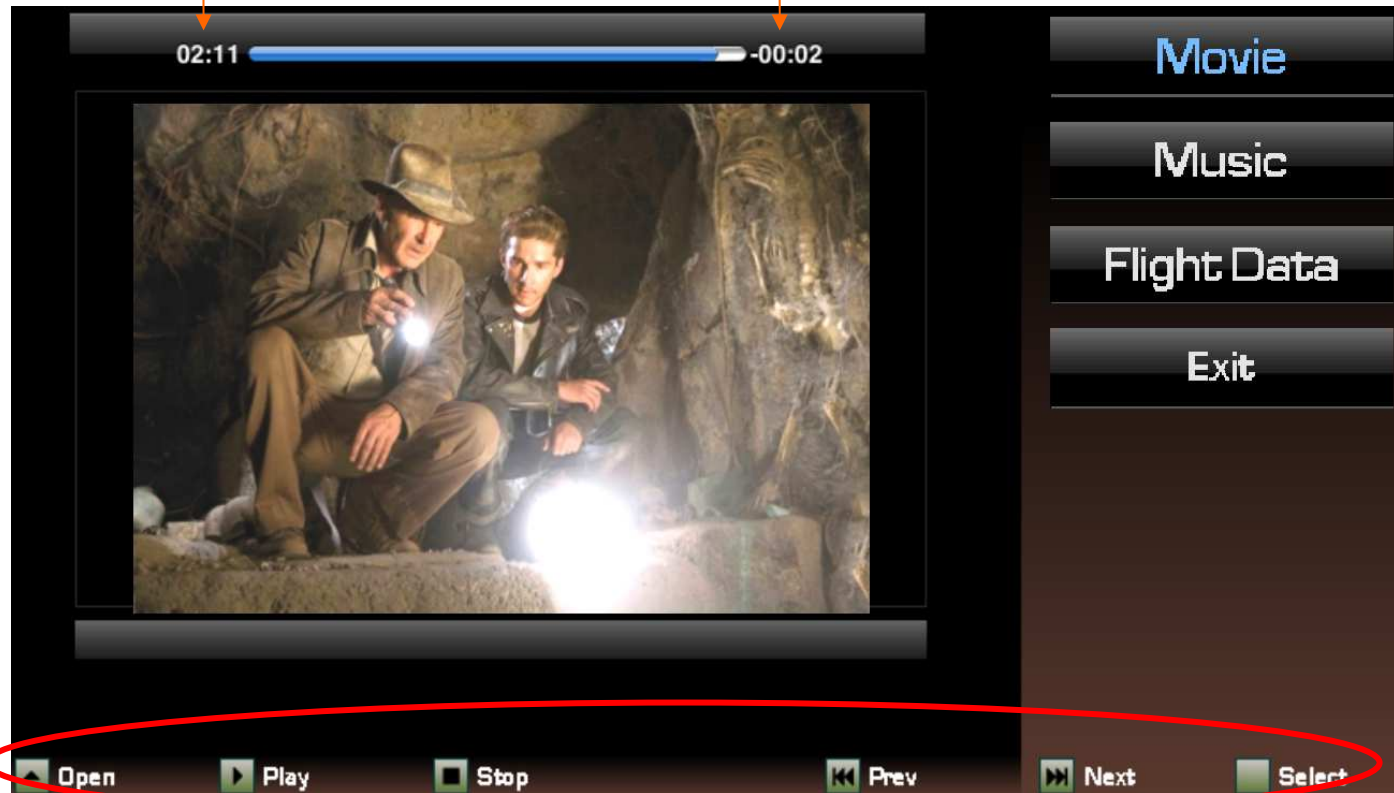

buttons' labels

Opens window for selecting desired video file or folder

Plays currently stopped video

Stops currently played video

Plays previous track

Plays next track

Option Music

i **NOTE:** The Integra only supports MP3 audio files.

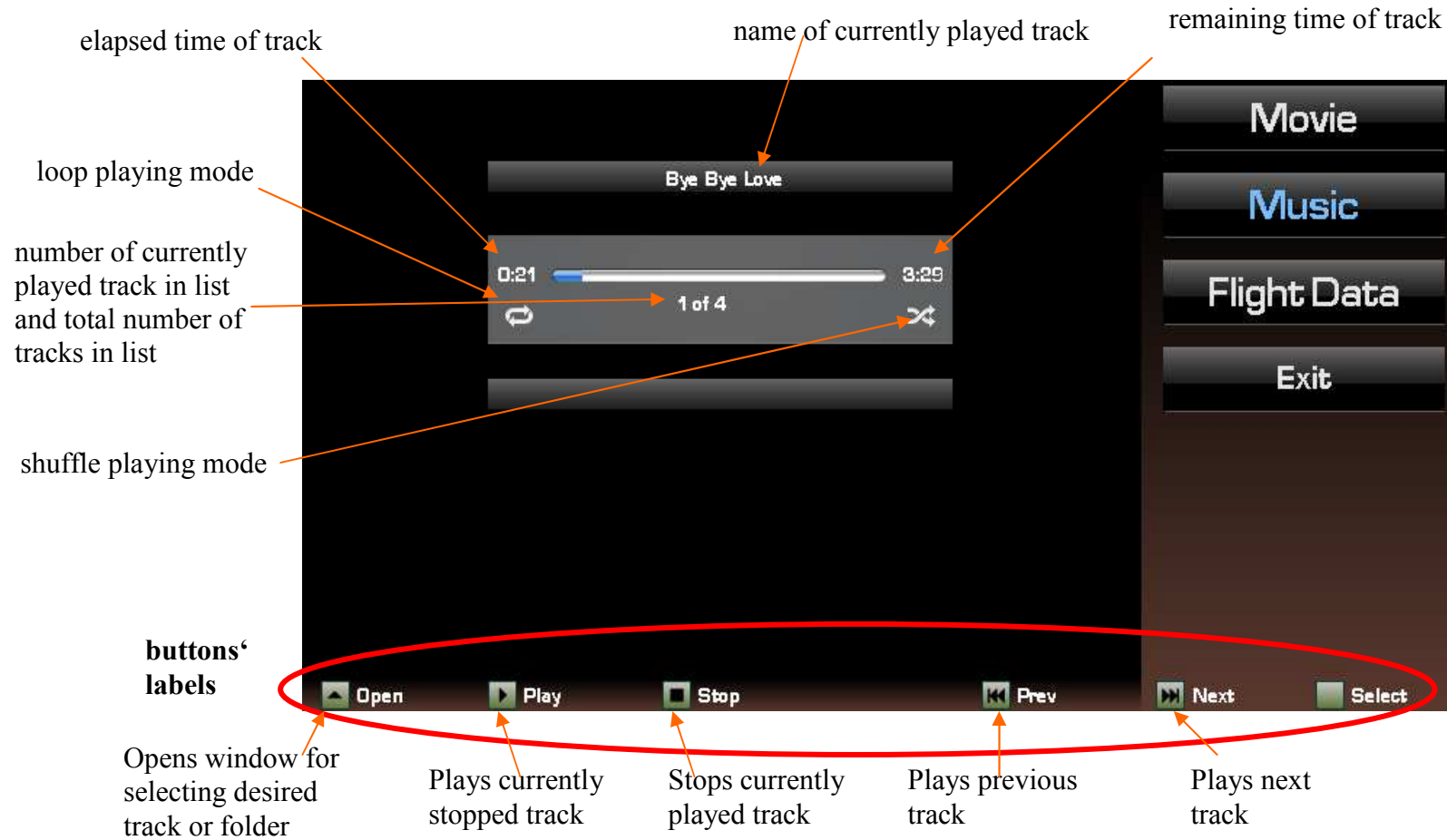

Option Flight Data

This option soothes desire for flight info of impatient and curious passengers. It displays Airspeed, Altitude and Time to arrival.

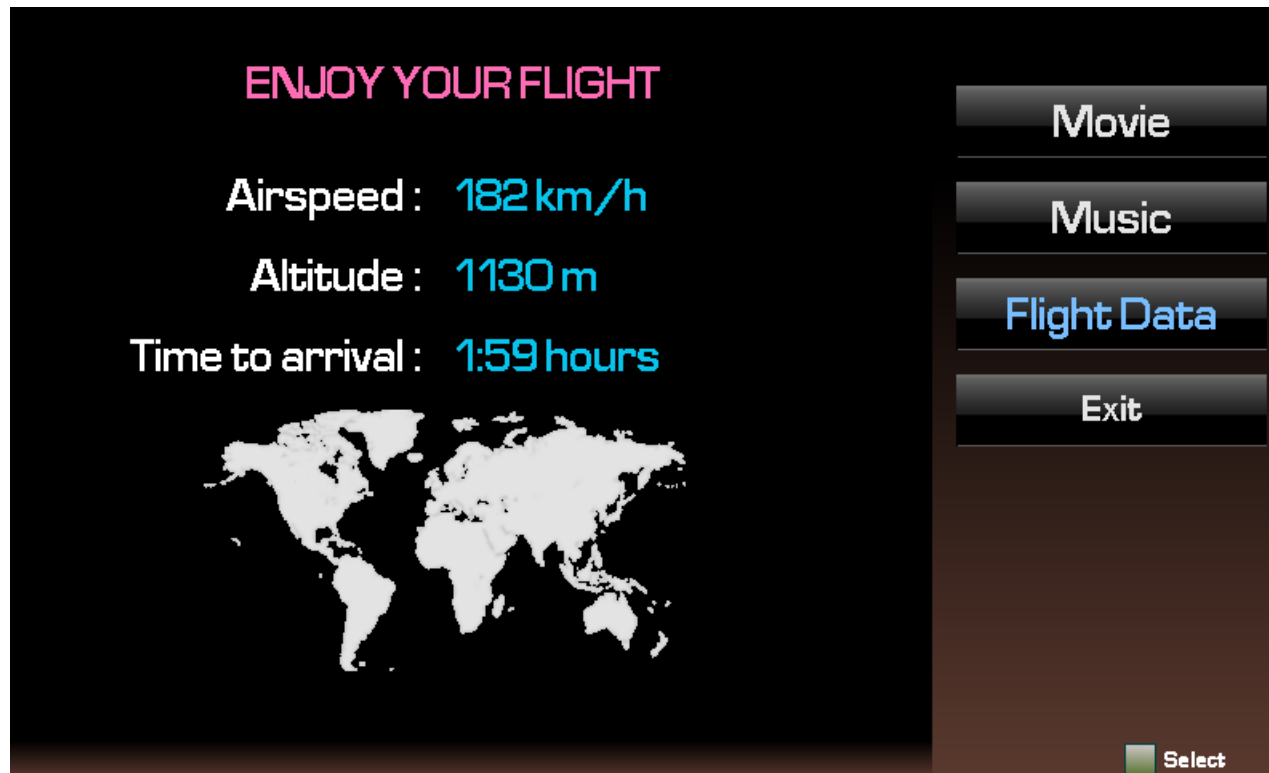

Option Exit

The option exits Entertainment Screen.

Abbreviations

ACTV — Active	DME — Distance Measuring Equipment	HFOM — Horizontal Figure of Merit
ALT — Altitude	DTK — Desired Track	hg — Inches of Mercury
AP — the Integra Autopilot	EFF — Efficiency	HPL — Horizontal Protection Level
APR — Approach	ELEV — Elevation	HITS — Highway in the Sky
APT — Airport	ENDUR —Endurance	HWY — Highway
ARSPC — Airspace	ENR — En Route	IAF — Intermediate Approach Fix
ARTCC — Air Route Traffic Control Center	ENT — Enter	ID — Identifier
ARVL — Arrival	EPU — Estimated Position Uncertainty	ig — Imperial Gallons
AUX — Auxiliary	ESA — En Route Safe Altitude	ILS — Instrument Landing System
AVGAS — Aviation-grade Gasoline	ETA — Estimated Time of Arrival	IND — Indicated
AVTN — Aviation	ETE — Estimated Time En Route	INT — Intersection
BARO — Barometric setting	°F — Degrees Fahrenheit	INTEG — Integrity
BRG — Bearing To	FAF — Final Approach Fix	ITI — Imminent Terrain Impact
°C — Degree Celsius	FF — Fuel Flow	kg — Kilograms
C/V — COM/VLOC	FIR — Flight Information Region	kHz — Kilohertz
CAS — Calibrated Airspeed	FLTA — Forward Looking Terrain Avoidance	km — Kilometers
CDI — Course Deviation Indicator	FOB — Fuel On Board	kph — Kilometers Per Hour
CLR — Clear	FPL — Flight Plan	kt — Knots
COM — Communications Transceiver	fpm — Feet Per Minute	L/VNAV — Lateral and vertical navigation
CRSR — Cursor	FREQ — Frequency	guidance, LNAV/VNAV service level
CTA — ICAO Control Area	FSS — Flight Service Station	LAT/LON —Latitude/Longitude
CTAF — Common Traffic Advisory Frequency	ft — Feet	lb — Pounds
CTR — Center (see ARTCC)	G/S — Glideslope	LCL — Local
CUM — Cumulative	gl — gallons	LFOB — Left-over Fuel On Board
DB — Database	GPS — Global Positioning System	LNAV — Lateral Navigation only
DEN — Density	GS — Ground Speed	LNAV+V — Lateral Navigation with advisory
DEP — Departure	HAL — Horizontal Alarm Limit	vertical guidance
DEPT — Departure guidance	HDG — Heading	LOC — Localizer
DIS — Distance		

LPV — Lateral Precision Performance with Vertical Guidance
LRES — Left-over Fuel Reserve Time
Lrg — Large
lt — Liters
°M — Degrees Magnetic
m — Meters
MAP — Missed Approach Point
MAHP — Missed Approach Hold Point
MAPR — Missed Approach guidance
mb — Millibars of Pressure
Med — Medium
MGRS — Military Grid Reference System
MHz — Megahertz
mi — Statute Miles
MOA — Military Operations Area
mph — Statute Miles Per Hour
mpm — Meters Per Minute
mps — Meters Per Second
MSA — Minimum Safe Altitude
MSG — Message
MSL — Mean Sea Level
mul — Multicom
NATNL — National
NAV — Navigation
NAVAID — Navigational Aid
NDB — Non-Directional Radio Beacon
NM — Nautical Miles
NRST — Nearest
NUM — Number

OBS — Omnibearing Selector
OCN — Oceanic
PDA — Premature Descent Alert
P.POS — Present Position
PROC — Procedure(s)
PROV — Province
PTK — Parallel Track
PWR — Power
RAD — Radial
RAIM — Receiver Autonomous Integrity Monitoring
REF — Reference
REQ — Required / Requirements
RESTRICTD — Restricted
RNG — Range
RTC — Required Terrain Clearance
RX — Receive
SBAS — Space-Based Augmentation System
SID — Standard Instrument Departure
Sml — Small
SPD — Speed
SQ — Squelch
SRFC — Surface
STAR — Standard Terminal Arrival Route
SUA — Special Use Airspace
SUSP — Waypoint sequencing suspended
°T — Degree True
TACAN — Tactical Air Navigation
TAS — True Airspeed
TAT — Total Air Temperature

TEMP — Temperature
TER — Terrain
TERM — Terminal
TKE — Track Angle Error
TMA — ICAO Terminal Control Area
TRANS — Transition
TRFC — Traffic
TRK — Track (also Ground Track) Angle
TRSA — Terminal Radar Service Area
TWR — Tower
TX — Transmit
UTC — Coordinated Universal Time (also GMT or “zulu”)
UTM/UPS — Universal Transverse Mercator / Universal Polar Stereographic grids
VAL — Vertical Alarm Limit
VAR — Variation
VER — Version
VFOM — Vertical Figure of Merit
VFR — Visual Flight Rules
VLOC — VOR/Localizer Receiver
VNAV — Vertical Navigation
VOL — Volume
VOR — VHF Omnidirectional Radio Range
VPL — Vertical Protection Level
VS — Vertical Speed
VSR — Vertical Speed Required
WAAS — Wide Area Augmentation System
WPT — Waypoint
WX — Weather
XTK — Crosstrack Error

Technical Parameters

Physical characteristic

Width	240.8 mm	9.480"
Height	178 mm	7.008"
Depth	75.5 mm	2.972"
Panel rectangle hole	233.8x172 mm	9.205"x6.772"
Weight without battery	1467 g	3.23 lb
Weight with battery	1567 g	3.45 lb

General Specifications

Operating Temperature Range	- 20°C to +60°C
Humidity	95% non-condensing
Altitude Range	10000 meters max (32808 feet max)
Power Range	10.0 to 32.0 Volts
Max. Signalization	30 Volts, 1 Ampere
Power Consumption	1.15 Ampere @ 14VDC without ext. sensors 1.83 Ampere when battery is charging
Vibration	5 to 500 Hz
Show Rate (LCD Refresh)	15 fps depends on volume of information displayed

Long-term Memory and communication

Storing Rate	0.1 to 60 seconds user selectable
Memory Capacity	Scheck®method
Data Saved Endurance	30 years
Rolling Memory life-time	100 000 hours @ 1 second storing rate

Communication

RS-232c	up to 115 200 bps
USB 1.1	12 Mb/s
USB 2.0	480 Mb/s
CAN BUS	1 Mb/s

Display parameters

Resolution	800x480
Brightness	800 cd/m ²

Memory card	Integra support SD and SDHC memory card
--------------------	---

© 2013 TL elektronik
or its subsidiaries

INTEGRA EFIS TL-6560 USER MANUAL



Part Number

TLX-6560X-DU-00 1-PrA

Europe

TL elektronik Inc.
Airport, Building 125
50341 Hradec Kralove
Czech Republic
E-mail: info@tl-elektronic.com
www.tl-elektronic.com